

Solar Storage Inverter

User Manual



Product Model

KE-5K5L1EF

Important Safety Instruction

Please keep this manual for future use.

This manual contains all safety, installation and operating instructions for KE-5K5L1EF solar storage inverter.

Please read all instructions and precautions in the manual carefully before installation and use.

- Non-safety voltage exists inside the solar storage inverter. To avoid personal injury, users shall not disassemble the solar storage inverter themselves. Contact our professional maintenance personnel if there is a need for repair.
- Do not place the solar storage inverter within the reach of children.
- Do not install the solar storage inverter in harsh environments such as moist, oily, flammable or explosive, or heavily dusty areas.
- The mains input and AC output are high voltage, so please do not touch the wiring terminals.
- The housing of the solar storage inverter is hot when it is working. Do not touch it.
- Do not open the terminal protective cover when the solar storage inverter is working.
- It is recommended to attach proper fuse or circuit breaker to the outside of the solar storage inverter.
- Always disconnect the fuse or circuit breaker near the terminals of PV array, mains and battery before installing and adjusting the wiring of the solar storage inverter.
- After installation, check that all wire connections are tight to avoid heat accumulation due to poor connection, which is dangerous.
- The solar storage inverter is off-grid. It is necessary to confirm that it is the only input device for load, and it is forbidden to use it in parallel with other input AC power to avoid damage.

Contents

1. Basic Information	4
1.1 Product overview and characteristics	4
1.2 Basic system introduction	5
1.3 Appearance	6
1.4 Dimension drawing	7
2. Installation Instruction	8
2.1 Installation Precautions	8
2.2 Wiring specifications and circuit breaker selection	9
2.3 Installation and Wiring	10
2.4 Parallel machine wire connection	15
2.4.1 Introduction	15
2.4.2 Precautions for connecting the parallel connecting lines	15
2.4.3 Schematic diagram of parallel connection in single phase	16
2.4.4 Schematic diagram of parallel connection in three phase	19
3. Operating Mode	24
3.1 Charge mode	24
3.2 Output mode	25
4. LCD screen operating instructions	28
4.1 Operation and display panel	28
4.2 Introduction to operation keys	28
4.3 Introduction to indicator lights	28
4.4 Introduction to LCD screen	29
4.5 Setting parameters	32
4.6 Battery type parameters	41
5. Other Function	43
5.1 Dry contact function	43
5.2 RS485 communication function	43
5.3 USB communication function	43
5.4 Parallel communication function (parallel operation only)	43
5.5 Current sharing detection function (parallel operation only)	44
6. Protection	45
6.1 Protection function	45
6.2 Meaning of fault code	47
6.3 Some fault troubleshooting	50
7. System Maintenance	51
8. Technical Parameter	52

1. Basic Information

1.1 Product overview and characteristics

KE-5K5L1EF is a new solar storage inverter, which integrates solar energy storage & mains charging energy storage and AC sine wave output. Thanks to DSP control and advanced control algorithm, it has high response speed, high reliability and high industrial standard. There are four charge modes namely only solar power, mains power priority, solar power priority, mains power & solar power; inverter and mains outputs are selectable to meet different application needs.

The solar charge module adopts the latest optimized MPPT tracking technology, which can quickly track the maximum power point of the PV array in any environment to obtain the maximum energy of the solar panel in real time with wide voltage range of MPPT.

AC-DC charge module adopts advanced control algorithm to realize full digital double closed-loop control of voltage and current, with high control accuracy and small volume. Battery can be charged and protected stably and reliably with wide AC voltage input range, full input/output protection function.

DC-AC inverter module based on full digital intelligent design adopts advanced SPWM technology, outputs pure sine wave, converts DC into AC. It is suitable for AC loads such as household appliances, electric tools, industrial device, electronic audiovisual, etc. The product adopts the segment LCD display design to display the operation data and state of the system in real time. The comprehensive electronic protection function ensures that safety and stability of the whole system.

Features:

1. Adopt full digital voltage and current double closed-loop control and advanced SPWM technology to output pure sine wave.
2. Two output modes, i.e. mains bypass and inverter output can achieve uninterrupted power supply function.
3. Four optional charge modes: only solar energy, mains priority, solar energy priority and mixed charging.
4. Advanced MPPT technology, with efficiency up to 99.9%.
5. LCD screen design and 3 LED indicator lights dynamically display system data and operation states.
6. ON/OFF rocker switch can control AC output.
7. With power saving mode function, it can reduce no-load loss.
8. Intelligent adjustable speed fan is adopted for efficient heat dissipation and extended system life.
9. With lithium battery PV and utility activation function, support lead-acid battery and lithium battery.
10. Possessing multiple protection functions and 360° comprehensive protection.
11. Possessing complete short circuit protection, overvoltage and undervoltage protection, overload protection, back filling protection, etc.

1.2 Basic system introduction

The figure below shows the system application scenario of this product. A complete system includes the following parts:

1. PV module: convert the light energy into direct current energy and then charge the battery via the machine, or directly invert the light energy into alternating current to supply power to the load.
2. Mains or generator: connected at the AC input, it can supply power to the load and charge the battery at the same time. If no mains power or generator is connected, the system can also operate normally. At this time, the load power is supplied by the battery and PV modules.
3. Battery: the battery is to ensure the normal power consumption of the system load in case of no sufficient solar energy or mains supply.
4. Household load: it can be connected to various household and office loads, including AC loads such as refrigerators, lamps, televisions, fans, air conditioners, etc.
5. Inverter: the energy conversion device of the whole system.

The specific system wiring mode is determined by the actual application scenario.

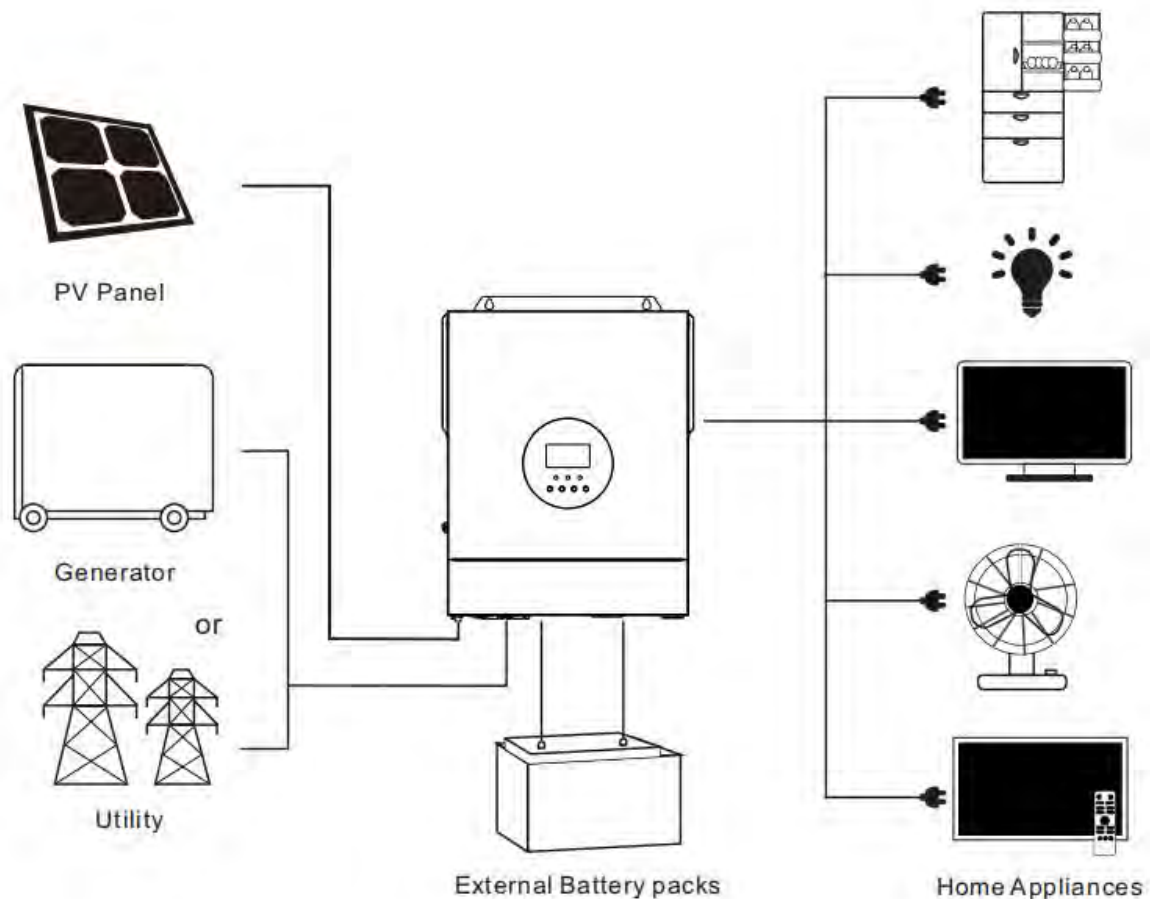

1.3 Appearance

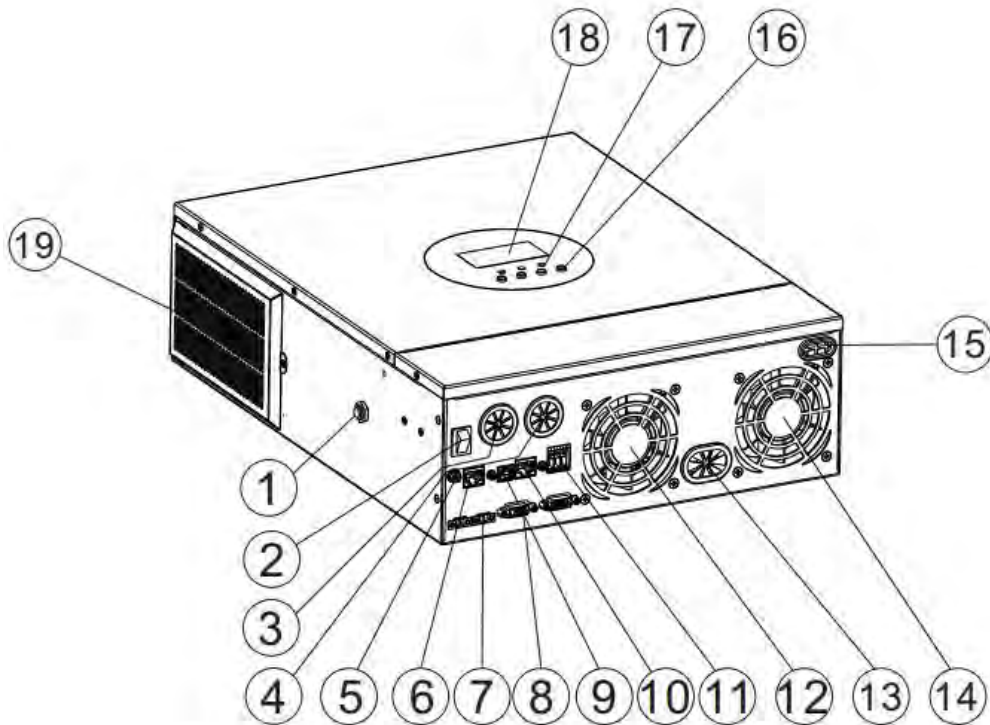

①	Overload protector	⑪	Dry contact port
②	ON/OFF rocker switch	⑫	Cooling fan
③	AC input terminal	⑬	Battery terminal
④	AC output terminal	⑭	Cooling fan
⑤	Grounding screw hold	⑮	PV terminal
⑥	RS485 communication port	⑯	Touchable buttons
⑦	Equalisation port (parallel modules only)	⑰	LED Indicators
⑧	Parallel communication port (parallel module only)	⑱	LCD screen
⑨	USB port	⑲	Dust net
⑩	WIFI port		

1.4 Dimension drawing

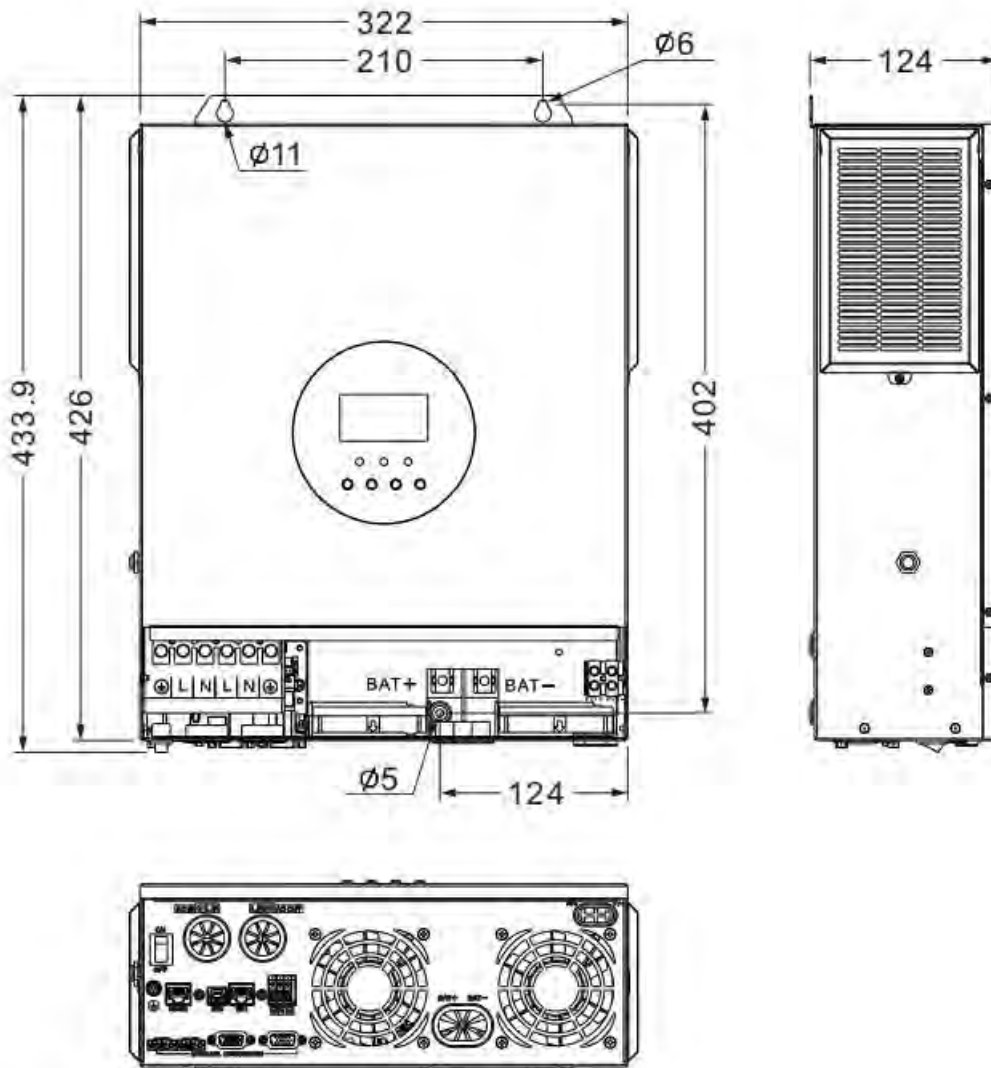

2. Installation Instruction

2.1 Installation Precautions

Before installation, please carefully read the manual and get familiar with the installation steps.

- Be very careful when installing the battery. Wear safety goggles when installing a lead-acid liquid battery. Once coming into contact with the battery acid, rinse with clean water timely.
- Do not place metal objects near the battery to prevent short-circuit of the battery.
- Acid gas may be generated when the battery is charged. So, please ensure good ventilation.
- When installing the cabinet, be sure to leave enough space around the solar storage inverter for heat dissipation. Do not install the solar storage inverter and lead-acid battery in the same cabinet to avoid corrosion by acid gas generated during battery operation.
- Only the battery that meets the requirements of the unit can be charged.
- Poorly connected connections and corroded wires may cause great heat which will melt the wire insulation, burn the surrounding materials, and even cause fires. So, make sure the connectors have been tightened, and the wires are secured with ties to avoid looseness of connections caused by shaking of wires during mobile application.
- The system connection wires are selected according to a current density of not more than 5 A/mm².
- Avoid direct sunlight and rainwater infiltration for outdoor installation.
- Even after the power is turned off, there is still high voltage inside the unit. Do not open or touch the internal components, and avoid related operations until the capacitor completely discharges.
- Do not install the solar storage inverter in harsh environments such as moist, oily, flammable or explosive, or heavily dusty areas.
- Polarity at the battery input end of this product shall not be reversed, otherwise it may damage the device or cause unpredictable danger.
- The mains input and AC output are high voltage, so please do not touch the wiring terminals.
- When the fan is working, do not touch it to prevent injury.
- It is necessary to confirm that the solar storage inverter is the only input device for load equipment, and it is forbidden to use it in parallel with other input AC power to avoid damage.

2.2 Wiring specifications and circuit breaker selection

Wiring and installation must comply with national and local electrical codes.

Recommended PV array wiring specifications and circuit breaker selection: Since the output current of the PV array is affected by the type, connection method and illumination angle of the PV module, the minimum wire diameter of the PV array is calculated according to its short-circuit current; refer to the short-circuit current value in the PV module specification (the short-circuit current is constant when the PV modules are connected in series; the short-circuit current is the sum of the short-circuit currents of all PV modules connected in parallel); the short-circuit current of the PV array shall not exceed the maximum input current.

➤ **Refer to the table below for PV input wire diameter and switch:**

Type	Recommended wiring diameter	Maximum PV input current	Recommended air switch or circuit breaker type
KE-5K5L1EF	6mm ² /10AWG	22A	2P—25A

Note: the voltage in parallel shall not exceed maximum PV open-circuit voltage.

➤ **Refer to the table below for recommended AC input wire diameter and switch:**

Type	Recommended wiring diameter	Maximum bypass input current	Recommended air switch or circuit breaker type
KE-5K5L1EF	10mm ² /7AWG	40A	2P—40A

Note: there is already a corresponding breaker at input connection point of mains supply. Therefore, no breaker may be equipped.

➤ **Recommended battery input wire diameter and switch selection:**

Type	Recommended wiring diameter	Rated battery discharge current	Maximum charge current	Recommended air switch or circuit breaker type
KE-5K5L1EF	30mm ² /2AWG	125A	100A	2P—160A

➤ **Recommended AC output wiring specifications and circuit breaker selection:**

Type	Recommended AC output wiring diameter	Rated inverter AC output current	Maximum bypass output current	Recommended air switch or circuit breaker type
KE-5K5L1EF	10mm ² /7AWG	24A	40A	2P—40A

Note: The wiring diameter is for reference only. If the distance between the PV array and the solar storage inverter or the distance between the solar storage inverter and the battery is relatively long, using a thicker wire can reduce the voltage drop to improve system performance.

Note: The above are only recommended wiring diameter and circuit breaker. Please select the appropriate wiring diameter and circuit breaker according to actual situations.

2.3 Installation and Wiring

Installation step:

Step 1: confirm the installation position and heat dissipation space, confirm the installation position of machine, such as wall surface; to install the machine, guarantee there is sufficient air flowing through the cooling fins of machine. At least reserve 200mm space at the left and right air outlets of the machine to guarantee heat loss through natural convection. Refer to the overall installation schematic above.



Warning: danger of explosion! Never install the machine and lead-acid liquid battery into a same sealed space or in a sealed place with probable accumulation of battery gas.

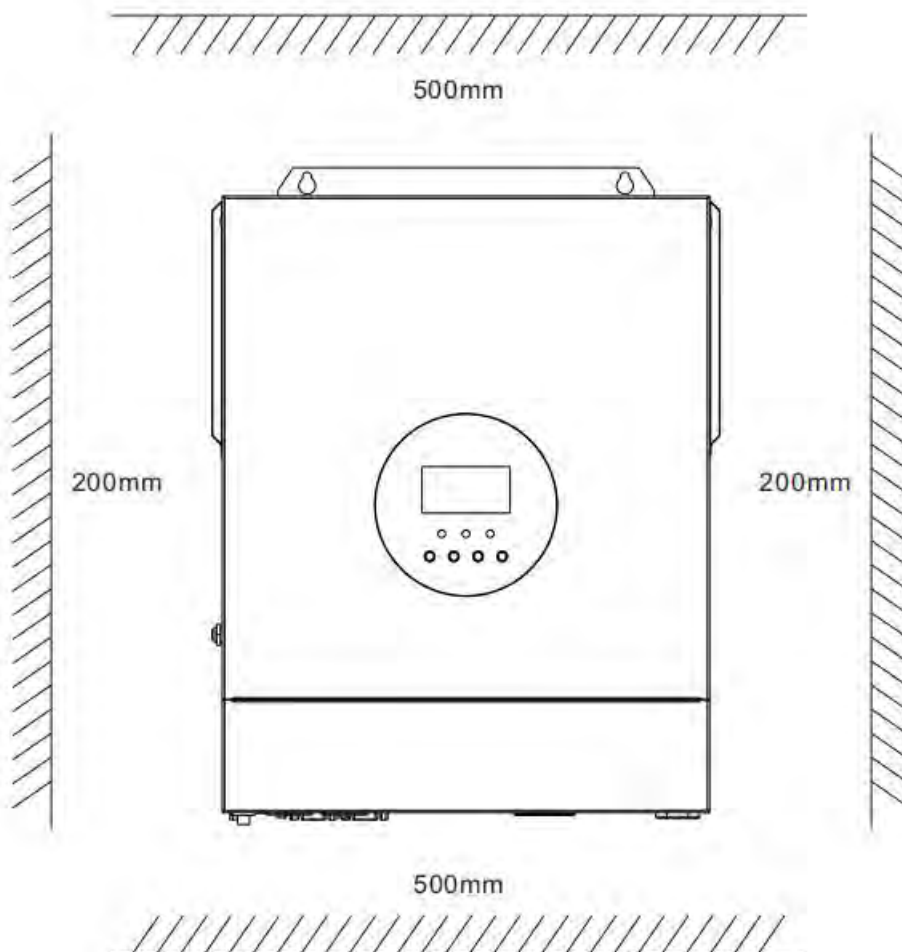

Step 2: Remove the terminal protection cover

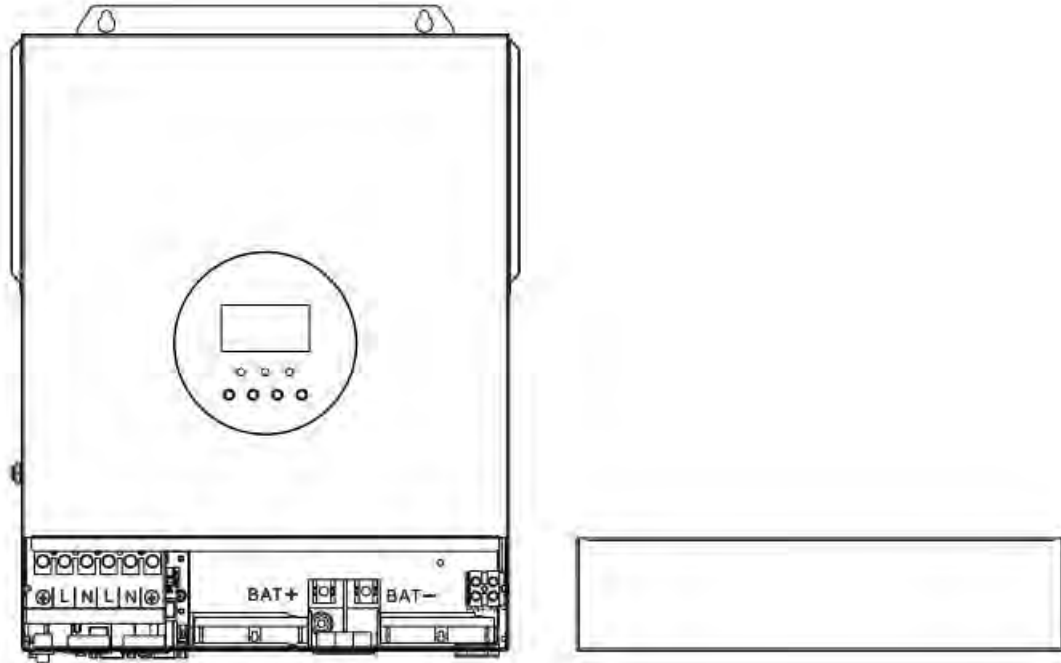

Step 3: Wiring

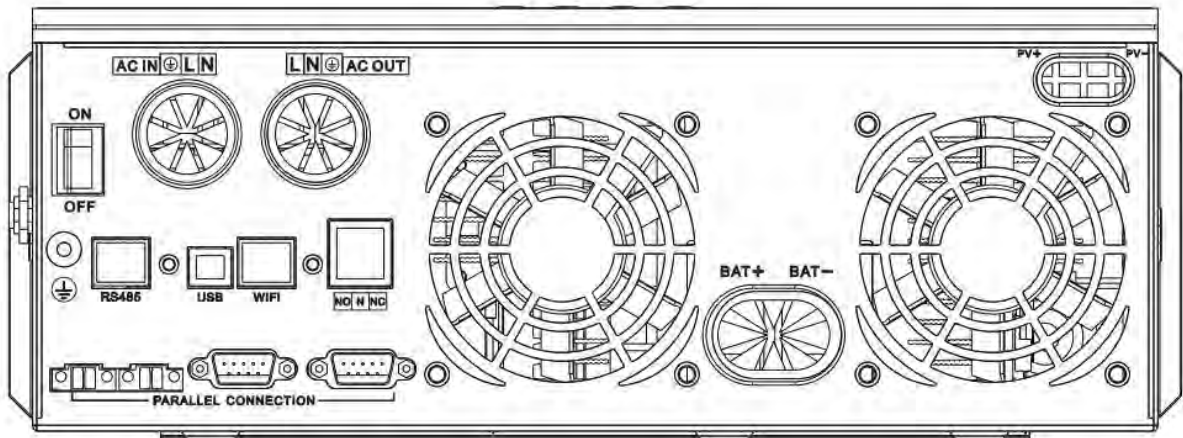

AC input/output wiring method:

- ① Before AC input/output wiring, disconnect the external breaker at first and then confirm whether the cable used is thick enough. Please refer to chapter “ 2.2 Wiring Specification and Breaker type” ;
- ② Correctly connect AC input wire in accordance with cable sequence and terminal position shown in the figure below. Please connect ground lead at first, and then live wire and null wire;

: **Ground** **L: Live** **N: Neutral**

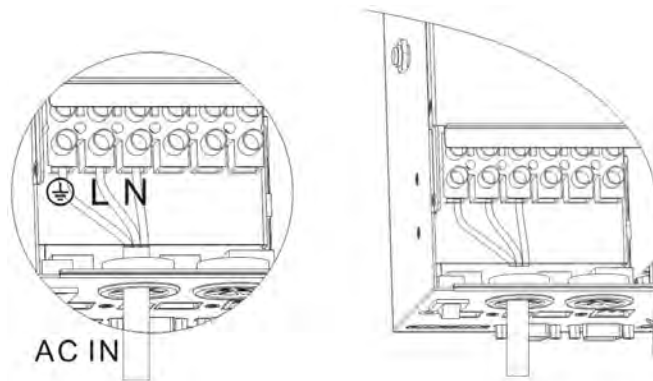

- ③ Correctly connect AC output wire in accordance with cable sequence and terminal position shown in the figure below. Please connect the ground wire at first, and then live wire and null wire. The ground wire is connected to the ground screw hold through O-type terminal.

: **Ground** **L: Live** **N: Neutral**

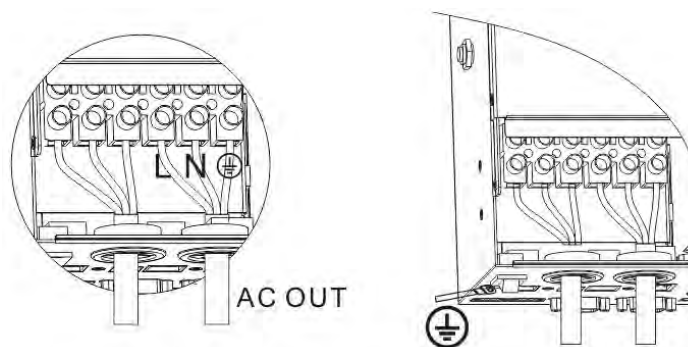

Note: The grounding wire shall be as thick as possible (cross-sectional area is not less than 4mm²). The grounding point shall be as close as possible to the solar storage inverter. The shorter the grounding wire, the better.

PV input wiring method:

- ① Prior to wiring, disconnect the external circuit breaker and confirm that the wire used is thick enough. Please refer to Section 2.2 “Wiring Specifications and Circuit Breaker Selection” ;
- ② Properly connect the PV input wire according to the wire sequence and terminal position shown in the figure below.

PV+: PV positive **PV-: PV negative**

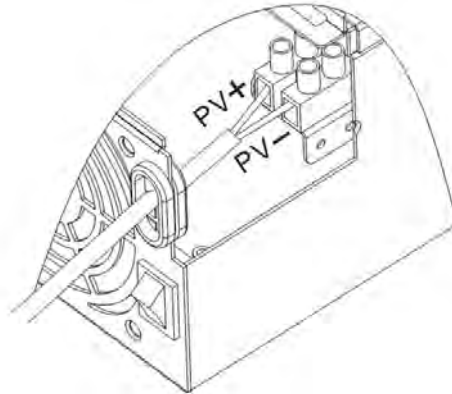

BAT wiring method:

- ① Before wiring, disconnect external breaker at first, and then confirm whether the used cable is thick enough. Please refer to chapter “ 2.2 Wiring Specification and Breaker Type ” . BAT wire shall be connected with the machine via O-shaped terminal. It is recommended to use the O-shaped terminal with 6mm inside diameter. The O-shaped terminal must compress BAT wire firmly to prevent excessive heating caused by great contact resistance;
- ② Correctly connect BAT wire in accordance with cable sequence and terminal position shown in the figure below.

BAT+: Battery positive **BAT-: Battery negative**

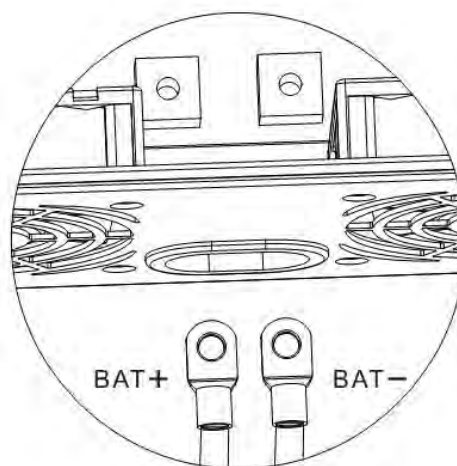

Warning notice:

- ① Input from mains supply, AC output and PV array may generate high voltage. Before wiring, make sure to break the breaker or fuse;
- ② During wiring process, make sure to pay attention to the safety; during the wiring process, please don't close the breaker or fuse. At the same time, guarantee that "+" and "-" poles of different parts are correctly connected with wires; a breaker must be installed at the battery end and selected based on chapter "2.2 Wiring Specification and Breaker Type". Before wiring, make sure to break the breaker to prevent strong electric spark generated during wiring. At the same time, avoid battery short circuit during the wiring process; if the machine is in the area with frequent thunder, it is suggested to install an external arrester at PV input terminal.

Step 4: Inspect whether the wires are correctly and firmly connected, especially whether the positive and negative input poles of the battery are correct, whether the positive and negative input poles of PV are correct, whether AC input is inaccurately connected to AC output terminal.

Step 5: Install protective cap of terminal

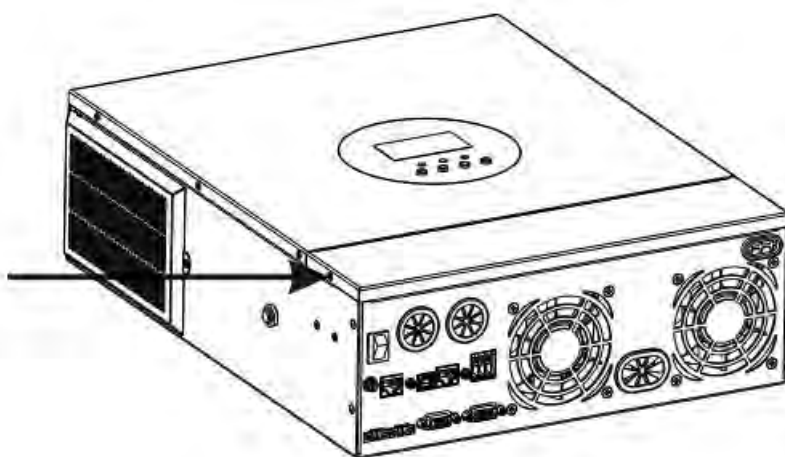

Step 6: Start the machine

At first close the breaker at the battery end, and then press the rocker switch at the lower left side of the machine to "ON" state, "AC/INV" indicator light flashes, indicating normal operation of inverter. Afterwards, close breakers of PV array and mains supply. In the end, after AC output is normal, turn on AC load one by one to avoid protection action generated by great instant impact owing to simultaneous turnon of loads. The machine operates normally in accordance with set mode.

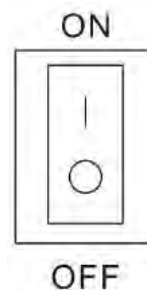

Note: if power is supplied to different AC loads, it is suggested to turn on the loads with great impact current, and then turn on the load with little impact current after the load operates stably.

Note: in case of abnormal operation of machine or abnormal display of LCD or indicator light, refer to Chapter 6 for troubleshooting.

2.4 Parallel machine wire connection

2.4.1 Introduction

1. Up to six units connected in parallel.
2. When using the parallel operation function, the following connecting lines (package accessories) shall be firmly and reliably connected:

Parallel communication line*1:



Current sharing detection line*1:

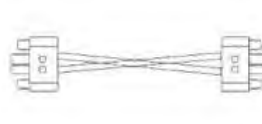

2.4.2 Precautions for connecting the parallel connecting lines

Warning: 

1. Battery wiring:

Parallel connection in single or three phase: Ensure that all solar storage inverters are connected to the same battery, with BAT + connected to BAT + , BAT - connected to BAT - , and that the connection is correct with the same wiring length and line diameter before power on and start-up, so as to avoid the abnormal operation of parallel system output caused by wrong connection.

2. AC OUT wiring:

Parallel connection in single phase: Ensure L-to-L, N-to-N and PE-to-PE connection for all solar storage inverters, and that the connection is correct with the same wiring length and line diameter before power on and start-up, so as to avoid the abnormal operation of parallel system output caused by wrong connection. For specific wiring, please refer to 2.4.3 Wiring Diagram

Parallel connection in three phase: Ensure N-to-N and PE-to-PE connection for all solar storage inverters. The L lines of all inverters connected to the same phase need to be connected together. But L lines of different phases cannot be joined together. Other connection precautions are the same as parallel connection in single phase. For specific wiring, please refer to 2.4.4 Wiring Diagram

3. AC IN wiring:

Parallel connection in single phase: Ensure L-to-L, N-to-N and PE-to-PE connection for all solar storage inverters, and that the connection is correct with the same wiring length and line diameter before power on and start-up, so as to avoid the abnormal operation of parallel system output caused by wrong connection. Meanwhile, it is not allowed to have multiple different AC source inputs to avoid damage to the external equipment of the inverter. The consistency and uniqueness of AC source input shall be ensured. For specific wiring, please refer to 2.4.3 Wiring Diagram.

Parallel connection in three phase: Ensure N-to-N and PE-to-PE connection for all solar storage inverters. The L lines of all inverters connected to the same phase need to be connected together. But L

lines of different phases cannot be joined together. Other connection precautions are the same as parallel connection in single phase. For specific wiring, please refer to 2.4.4 Wiring Diagram.

4. **Wiring of parallel communication line:**

Parallel connection in single or three phase: Our company's parallel communication line is a DB15 standard computer cable with shielding function. Ensure the "one-in-one-out" rule when connecting each inverter, that is, connect the male connector (out) of this inverter with the female connector (in) of the inverter to be paralleled. Do not connect the male connector of the inverter to its female connector. In addition, make sure to tighten the parallel communication line of each inverter with self-contained end screws of DB15 to avoid the abnormal operation or damage of the system output caused by the falling off or poor contact of the parallel communication line.

5. **Wiring of current sharing detection line:**

Parallel connection in single phase: Our company's current sharing detection line is a twisted connection line. Ensure the "one-in-one-out" rule when connecting each inverter, that is, connect the current sharing line of the inverter with the current sharing green port of the inverter to be paralleled (choose one port from the two, and there is no mandatory sequence requirement). The current sharing ports of the inverter cannot be connected to each other. In addition, make sure that the red and black current sharing connection lines of each inverter are not manually exchanged, and make sure to tighten the lines with self-contained screws to avoid the abnormal operation or damage of the system output caused by abnormal parallel current sharing detection. For specific wiring, please refer to 2.4.3 Wiring Diagram.

Parallel connection in three phase: The current sharing detection lines of all inverters connected to the same phase need to be connected together. But the current sharing detection lines of different phases cannot be joined together. Other connection precautions are the same as parallel connection in single phase. For specific wiring, please refer to 2.4.4 Wiring Diagram.

6. Before or after connecting the system, please carefully refer to the following system wiring diagram to ensure that all wiring is correct and reliable before power on.
7. After the system is wired, powered on and in normal operation, if a new inverter needs to be connected, make sure to disconnect the battery input, PV input, AC input and AC output, and that all solar storage inverters are powered off before reconnecting into the system.

2.4.3 Schematic diagram of parallel connection in single phase

1. The parallel communication line and current sharing detection line of the solar storage inverter need to be locked with screws after connecting. The schematic diagram is as follows:

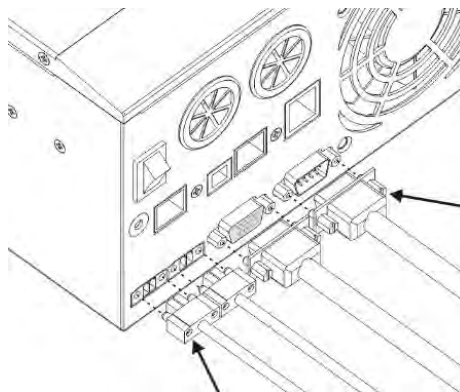

2. In case of parallel operation with multiple inverters, the schematic diagram of parallel connection is as follows:

a) Two units connected in parallel:

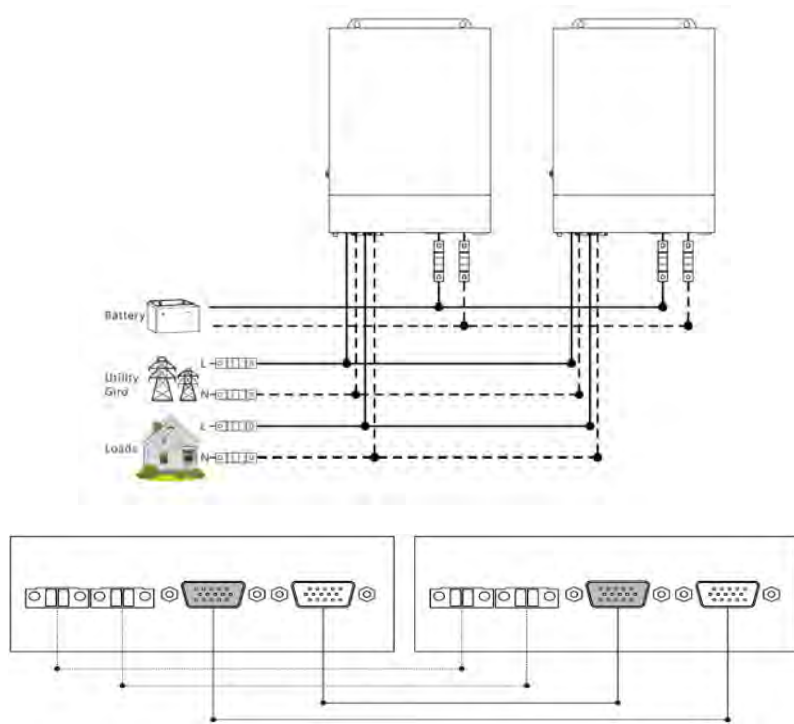

b) Three units connected in parallel:

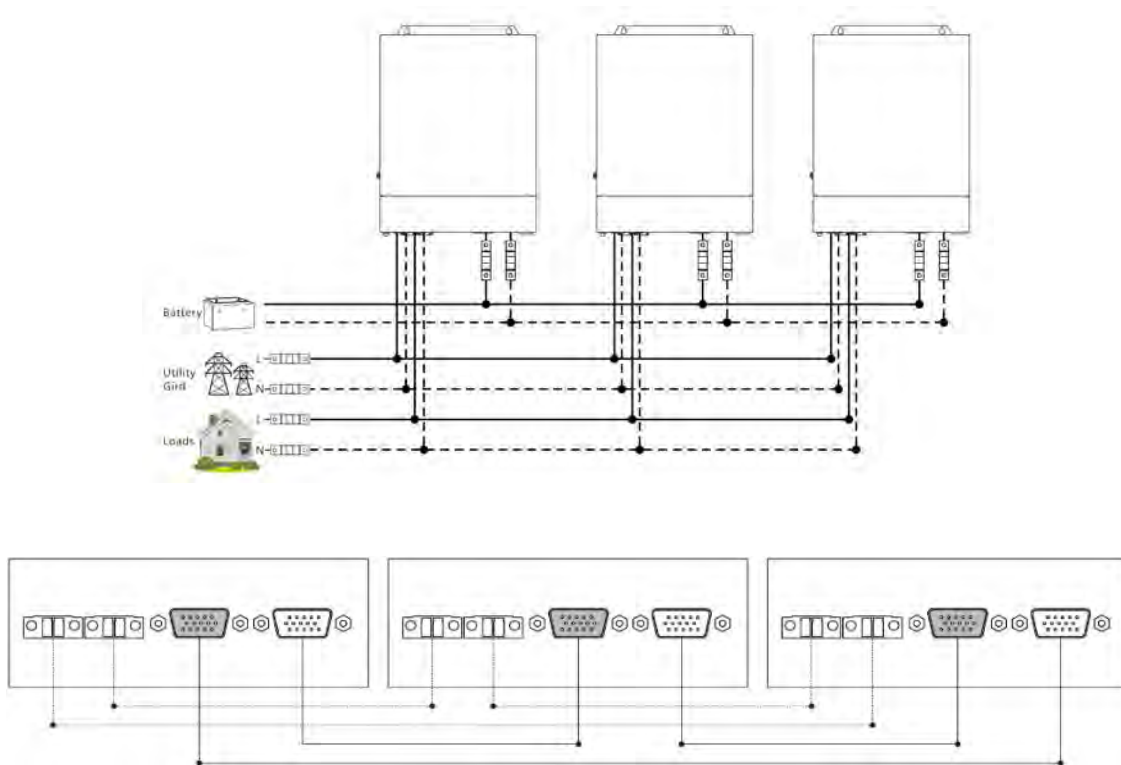

c) Four units connected in parallel:

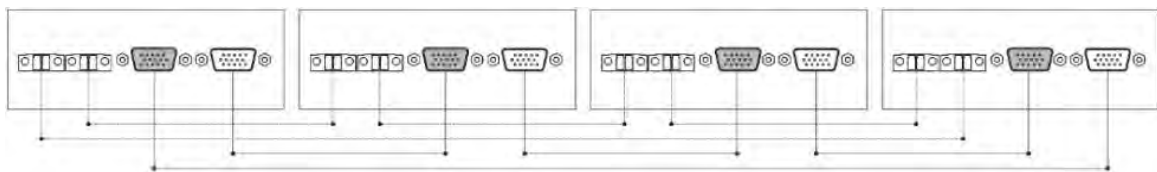
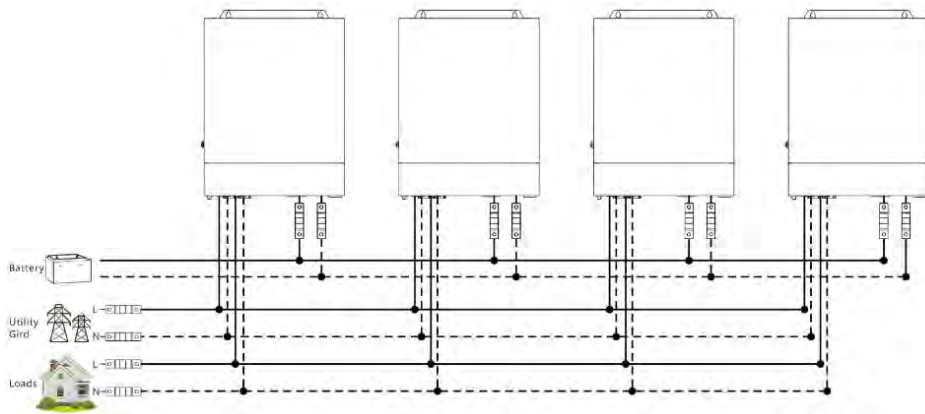

d) Five units connected in parallel:

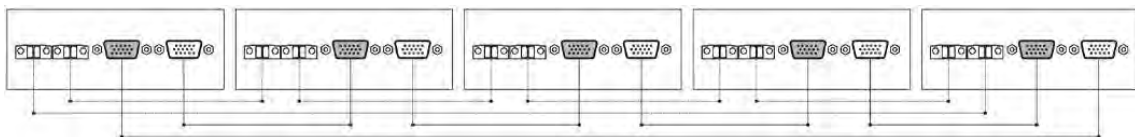
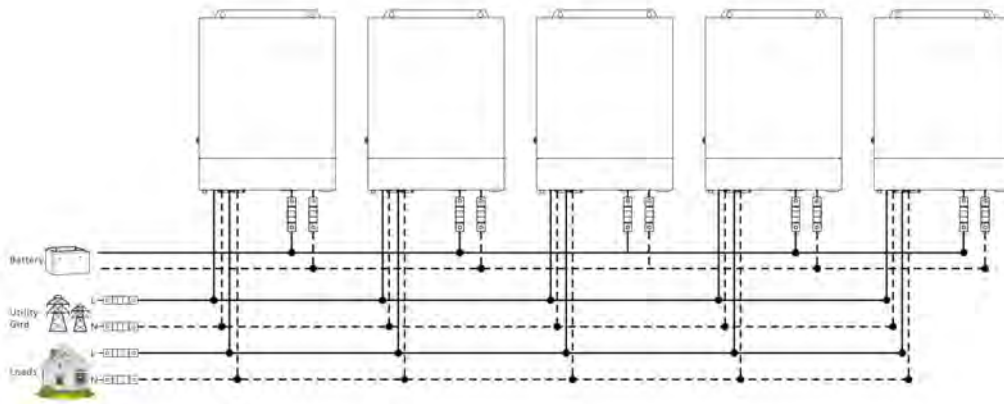

e) Six units connected in parallel:

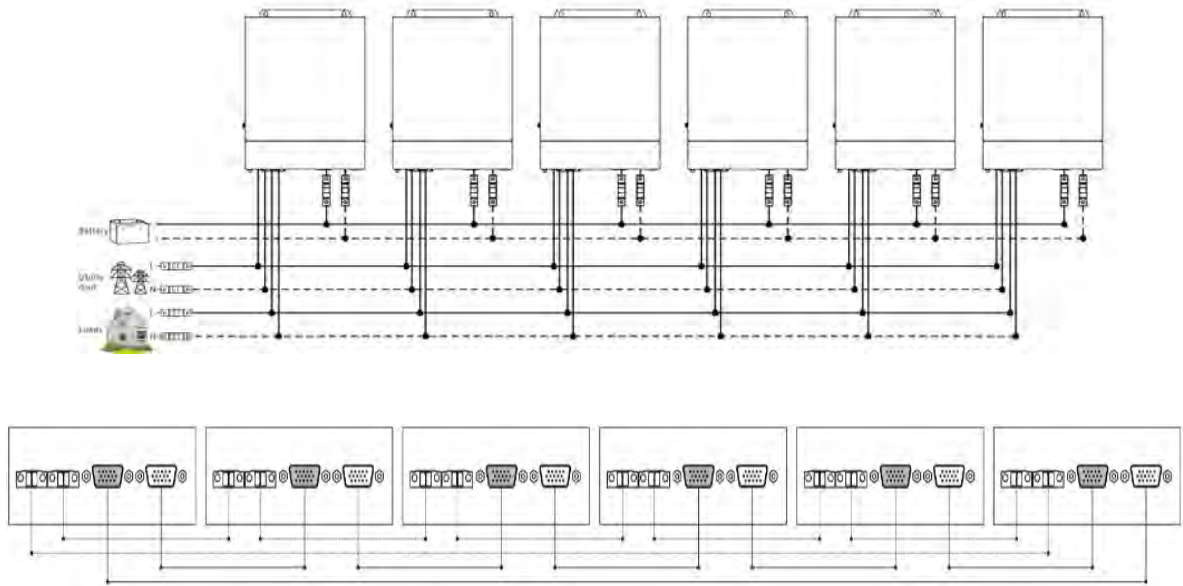

2.4.4 Schematic diagram of parallel connection in three phase

1. The parallel communication line and current sharing detection line of the solar storage inverter need to be locked with screws after connecting. The schematic diagram is as follows:

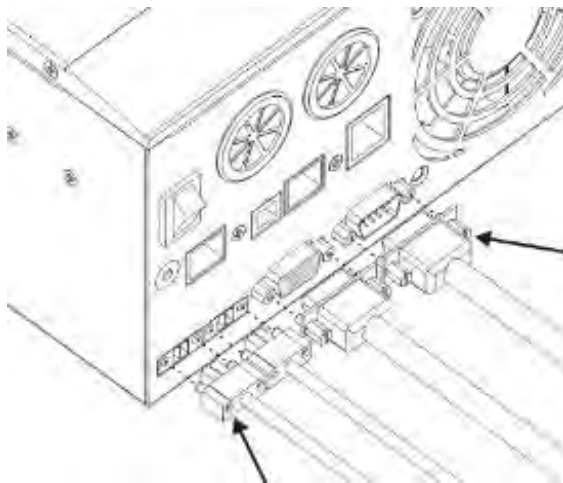

2. In case of parallel operation with multiple inverters, the schematic diagram of parallel connection is as follows:

Parallel Operation in three phase :

a) Three units connected in three phase:

1+1+1 system:

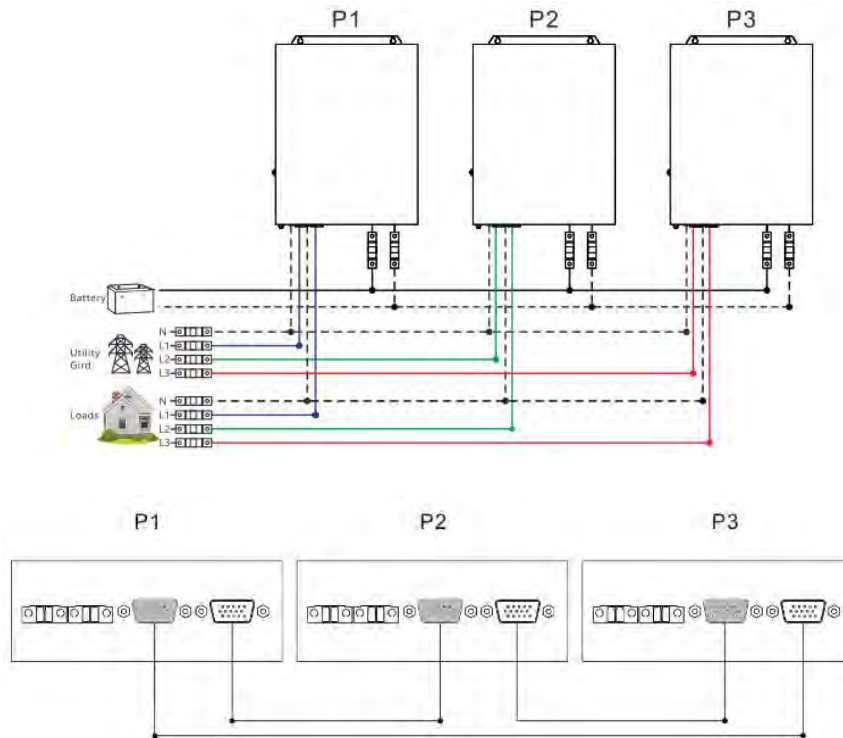

b) Four units connected in three phase:

2+1+1 system:

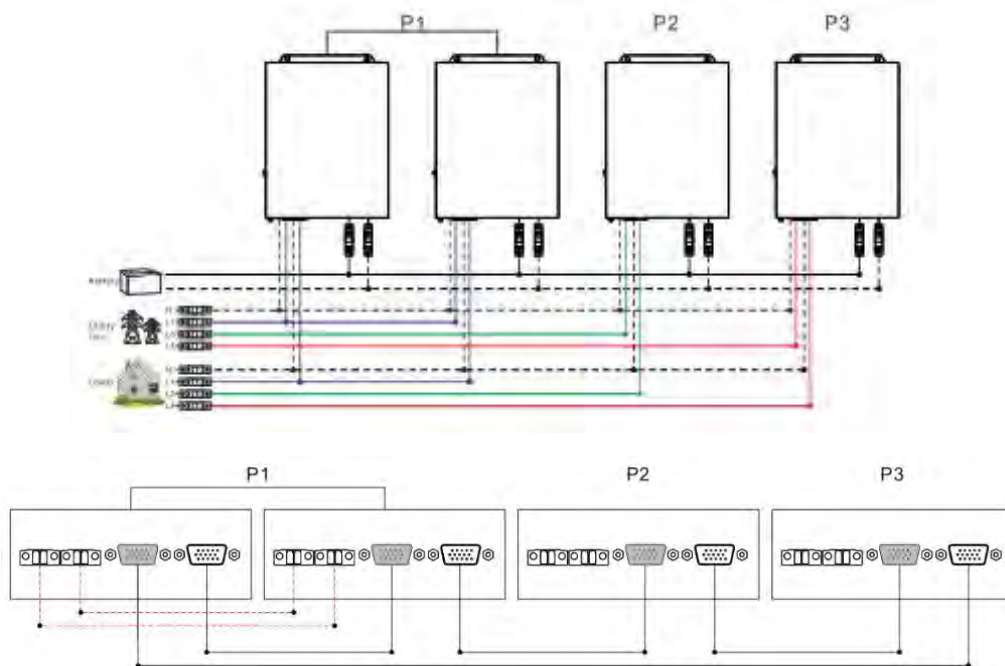

- c) Five units connected in three phase:
3+1+1 system:

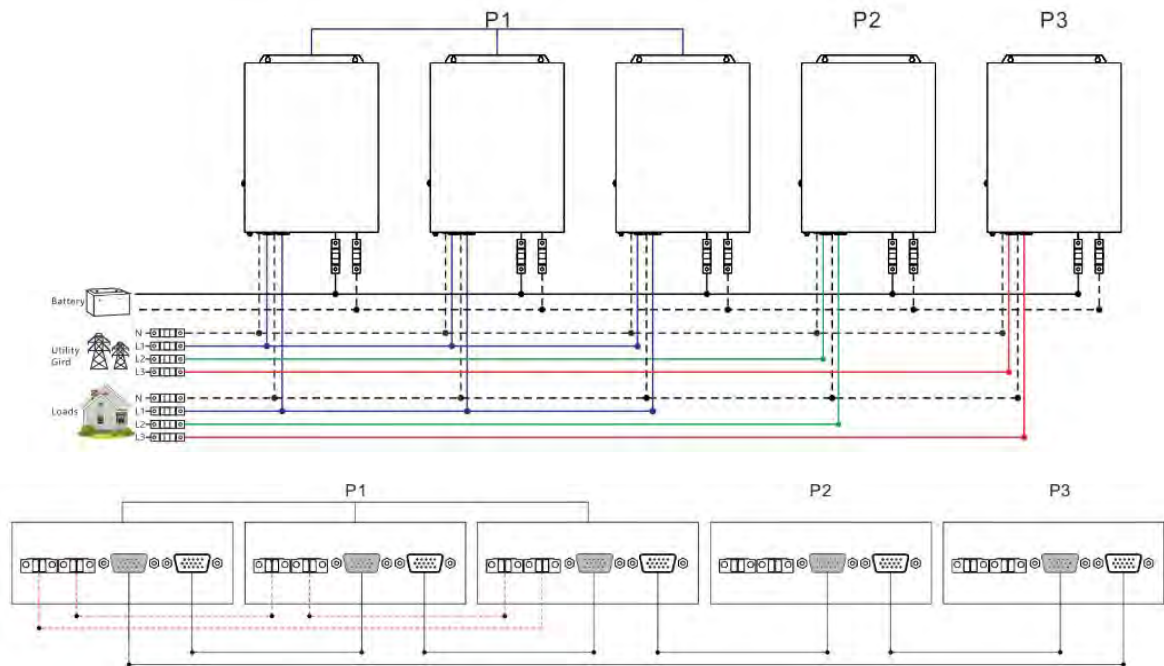

- 2+2+1 system:**

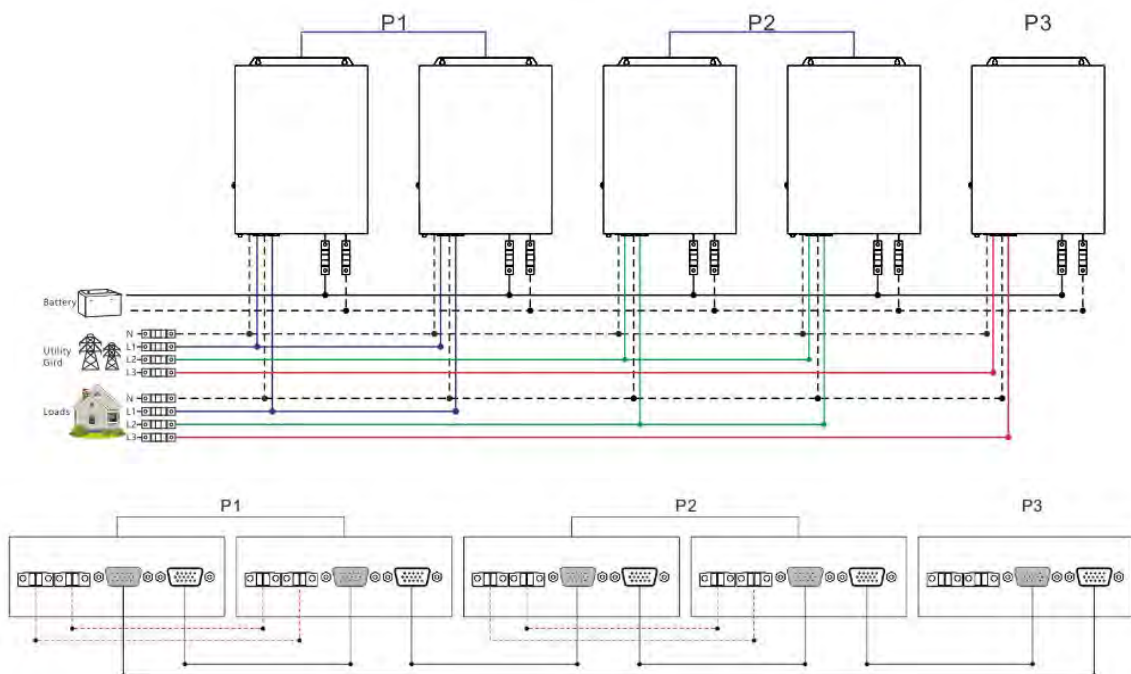

d) Six units connected in three phase:
2+2+2 system:

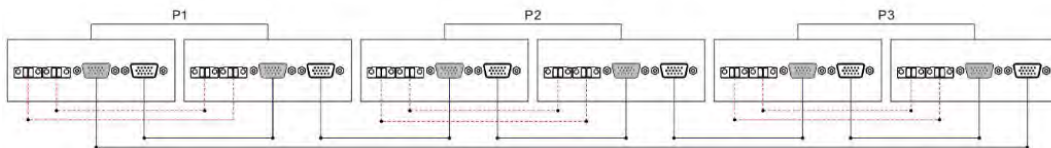
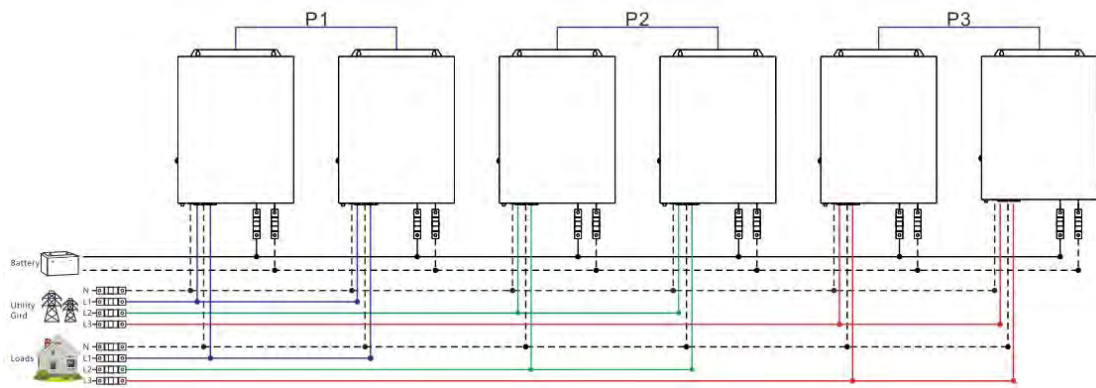

3+2+1 system:

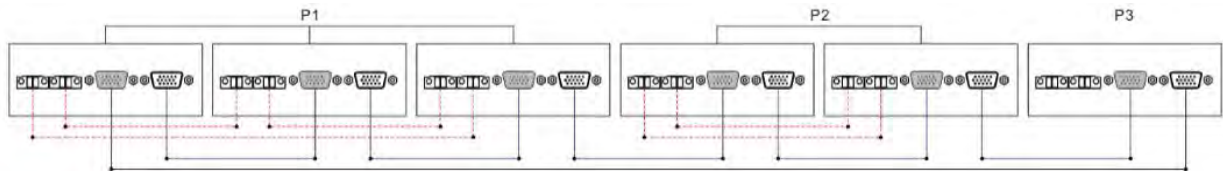
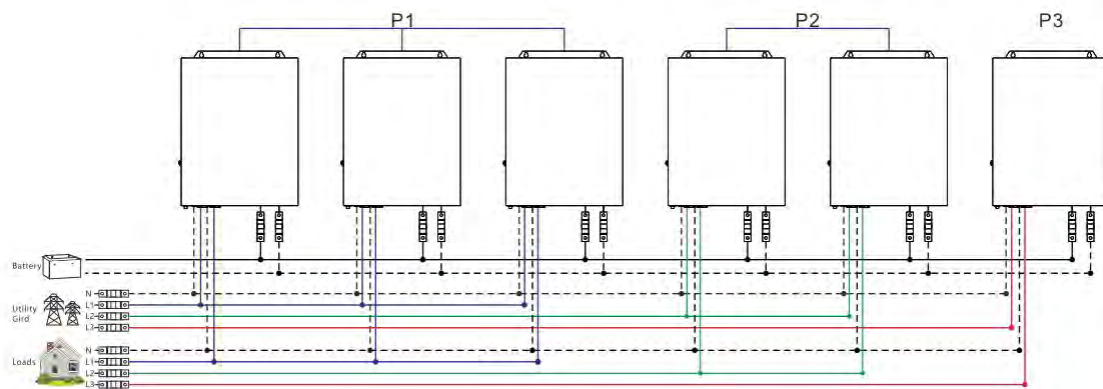

4+1+1 system:

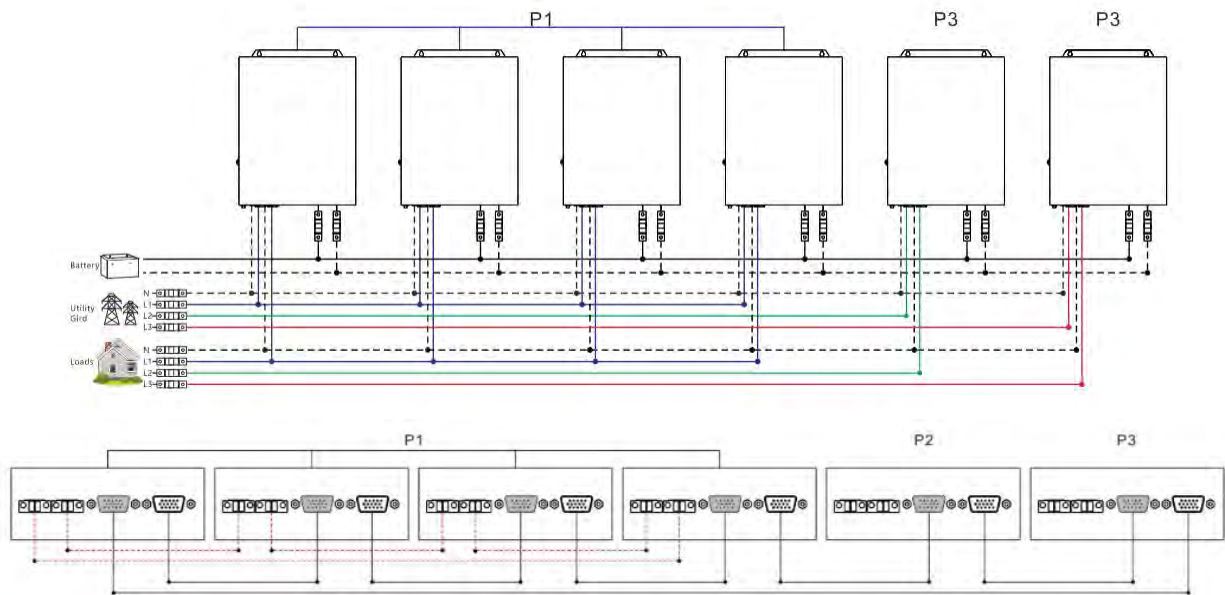

Note:

- 1) Before starting up and running, please check whether the connection was correct to avoid any abnormalities in the system.
- 2) All wiring must be fixed and reliable to avoid wire drop during use.
- 3) When the AC output is wired to the load, it shall be properly wired according to the requirements of the electrical load equipment to avoid damage to the load equipment.
- 4) Settings [38] need to be set consistently or only for the host. When the machine is running, the voltage set by the host shall prevail, and the master will force the rewrite of the other slave machines to keep the same set. Only can be set in the standby mode.
- 5) Machine factory default for single machine mode, if you use parallel or three-phase function, you need to set the [31] item parameters through the screen. The setting method is: power on one machine at a time, the rest of the machine off, and then set the [31] item parameters according to the site system operation mode. After this machine is set successfully, turn off the machine switch and wait for the machine to be powered down, then set the rest of the machines in turn until all machines are set, and then all machines are powered up again at the same time and enter the working state.

The [31] setting item:

When in single phase parallel connection : setting [31] should be set as "PAL" .

When in three phase parallel connection, setting [31] should be set as follows: all machines in phase 1 must be set as "3P1" , all machines in phase 2 must be set as "3P2" , all machines in phase 3 must be set as "3P3" . At present, the voltage phase difference between P1-P2, P1-P3 and P2-P3 is 120 degrees. When the output voltage set in the setting [38] is 230Vac (S model), the line voltage between the live wire L1 in phase 1 and the live wire L2 in phase 2 is $230 \times 1.732 = 398\text{Vac}$, and similarly the line voltage between L1-L3, L2-L3 is 398Vac; the single phase voltage between L1-N, L2-N, L3-N is 230Vac.

- 6) Finally, power off and start up again. After the system runs, the output voltage is measured correctly, and then the load setting is connected.

3. Operating Mode

3.1 Charge mode

1) **PV priority:** PV module will charge the battery preferentially, and the battery is charged by the Mains only when the PV system fails. During the day, solar energy is fully used to charge, while at night, it converts to the Mains. This can maintain battery level, and is ideal for areas where the grid is relatively stable and electricity price is relatively high.

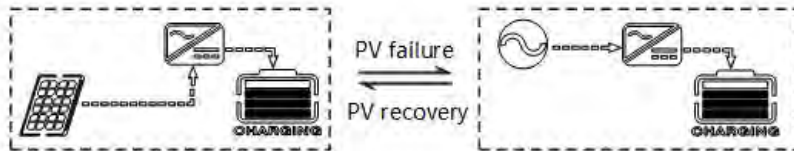

2) **Mains priority:** The Mains supply is preferentially used to charge the battery. Only when the Mains fails, the PV charging can be activated.

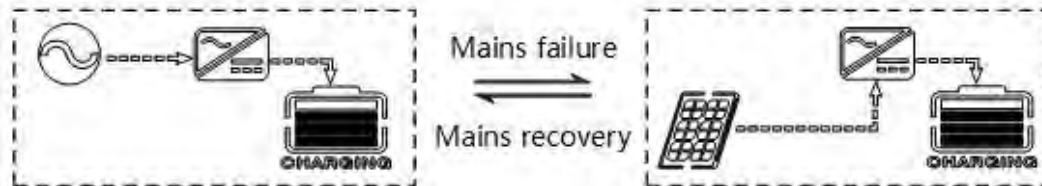

3) **Hybrid charging:** PV and mains hybrid charging. PV MPPT charging is a priority, and when PV energy is insufficient, the mains supply supplements. When the PV energy is sufficient again, the mains stops charging. This is the fastest charging mode, suitable for the areas where power grid is unstable, providing sufficient backup power supply at any time.

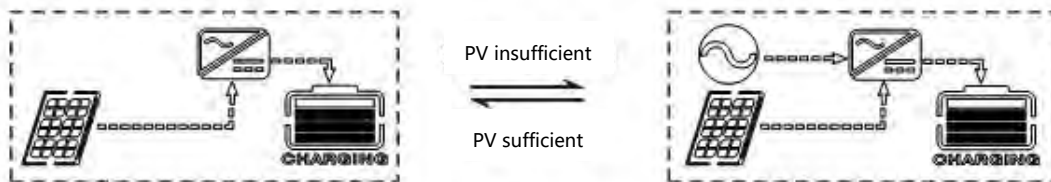

4) **Only Solar:** Only PV charging, without Mains charging. This is the most energy-efficient way in which battery is charged only by solar panels, and is usually used in areas with good lighting conditions.

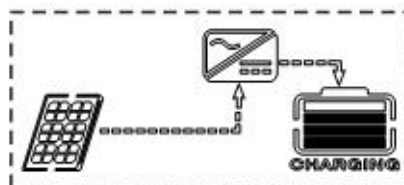

3.2 Output mode

> **PV priority mode:**

Use PV and battery energy to power loads, with PV taking priority.

When the PV energy is greater than the load, the excess energy charges the battery:



When the PV energy is less than the load, the battery replenish the power supply.

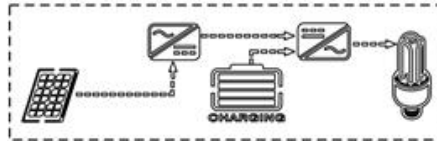

When PV is invalid, switch to mains power supply and charging. When PV is restored, switch back to PV and battery to power the load.

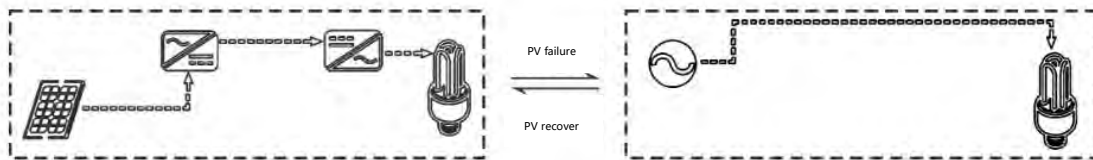

No BMS communication: when the battery voltage is lower than [04] setting item, switch to mains power supply and charging. When the battery voltage is higher than [05] setting item, switch back to PV and battery to supply power to the load.

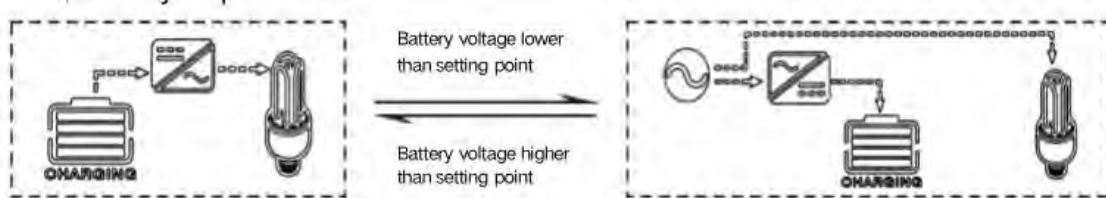

With BMS communication: when the battery SOC is lower than [61] setting items, switch to utility power supply and charging; when the battery SOC is higher than [62] setting items, switch to PV, battery to power the load.

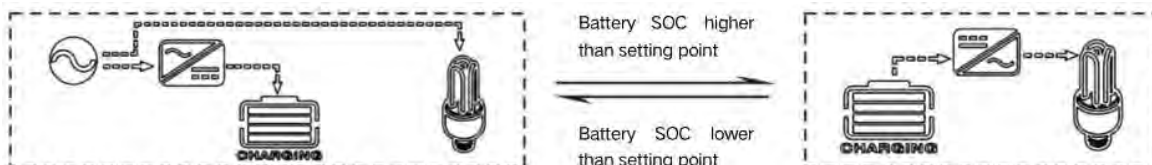

This model maximizes the use of solar energy while maintaining battery power and is suitable for areas with stable power grid.

> **Mains priority mode:**

Switch to inverter power supply only when there is no utility power, and switch to utility power charging and supply when utility power recovery. The equipment is as a backup UPS, used in areas with unstable power grid. Switching does not affect the PV charging.

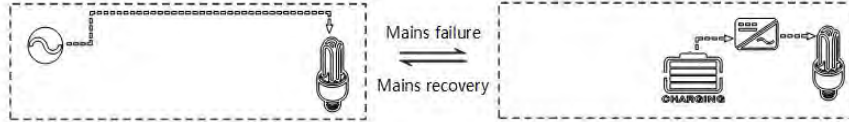

> **Inverter priority mode:**

Use PV and battery energy to power the load, with PV taking priority.

When the PV energy is greater than the load, the excess energy charges the battery.



When the PV energy is less than the load, the battery replenishes power to the load.

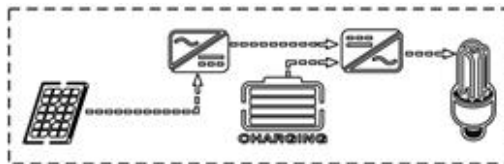

When the PV is ineffective, the battery power the load. Cycle the battery charge and discharge.



No BMS communication: When the battery voltage is lower than [04] setting item, switch to mains power supply and charging. When the battery voltage is higher than [05] setting item, switch to PV, battery to power the load.

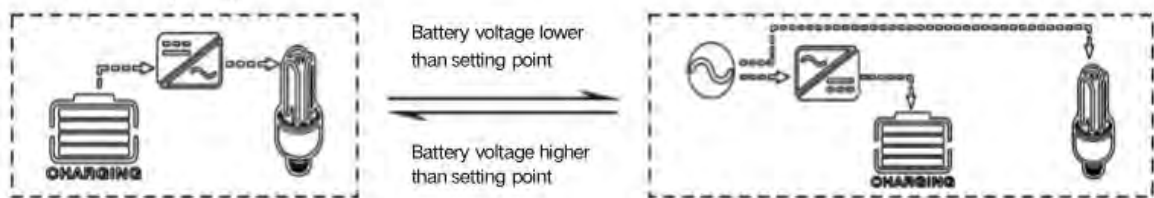

With BMS communication: when the battery SOC is lower than the [61] setting item, switch to utility power supply and charging; when the battery SOC is higher than the [62] setting item, switch to PV, battery to power the load.

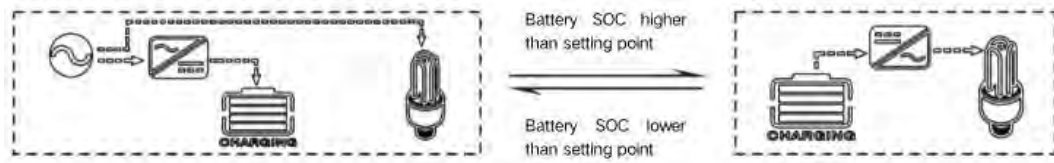

This mode maximizes the use of DC energy and is used in grid stable areas. Does not affect PV charging.

➤ **Hybrid power supply to loads:**

When no battery is connected or when the battery is fully charged, the PV and mains power are mixed together to supply the load and the PV is output at its maximum output power.

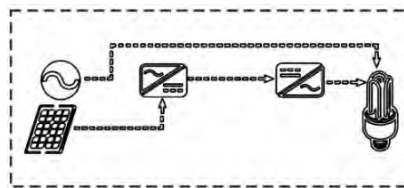

4. LCD screen operating instructions

4.1 Operation and display panel

The operation and display panel is as shown below, including 1 LCD screen, 3 indicators and 4 operation buttons.



4.2 Introduction to operation keys









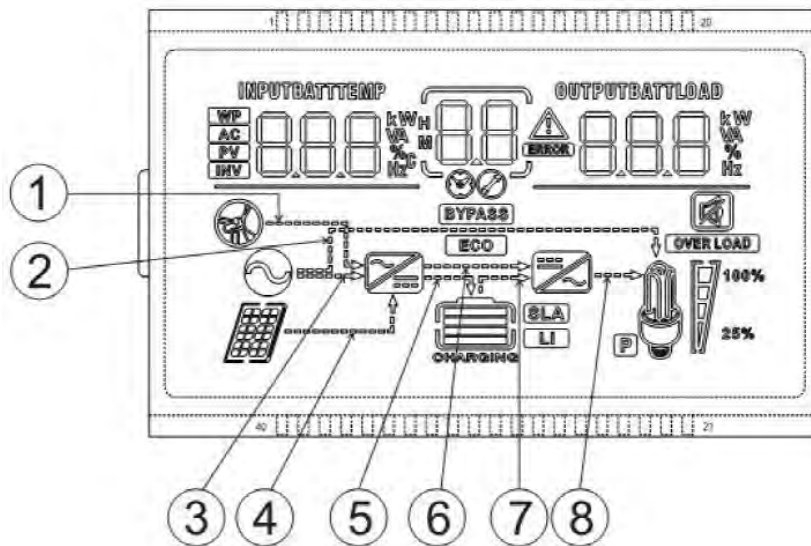







Function Key	Description
SET	Enter/exit setting menu
UP	Last option
DOWN	Next option
ENT	Confirm/enter option under setting menu

















4.3 Introduction to indicator lights

Indicator light	Color	Description
AC/INV	Yellow	Constant on: mains supply output
		Flashing: inverter output
CHARGE	Green	Flashing: battery in charge
		Constant on: charge completed
FAULT	Red	Constant on: fault state

4.4 Introduction to LCD screen



Icon	Function	Icon	Function
	Indicating that AC input end has been connected to power grid		Indicating that inverter circuit is in working.
	Indicates that the AC input mode in APL mode (wide voltage range)		Indicating that the machine is in mains supply bypass work mode
	Indicating that PV input end has been connected to solar battery panel		Indicating that AC output is in overload state
	<p>Indicating that machine has been connected to battery.</p> <p> indicating 0%~24% battery remaining capacity</p> <p> indicating 25%~49% battery remaining capacity</p> <p> indicating 50%~74% battery remaining capacity</p> <p> indicating 75%~100% battery remaining capacity</p>		<p>Indicating percentage of AC output load.</p> <p> indicating 0%~24% load percentage,</p> <p> indicating 25%~49% load percentage,</p> <p> indicating 50%~74% load percentage,</p> <p> indicating ≥75% load percentage</p>

	Indicating that present battery type of the machine is lithium battery		Indicating that buzzer is not enabled
	Indicating that current battery type of machine is lead-acid battery		Indicating alarm of machine
	Indicating that the battery is in charge state.		Indicating that the machine is in fault state.
	Indicating that AC/PV charge circuit is in working		Indicating that the machine is in setting mode.
	Indicating that AC output end has AC voltage output		Middle parameter display of screen, 1. In non-setting mode, displaying alarm or fault code; 2. In setting mode, displaying code of parameter item under current setting.
	When used in parallel, this icon is displayed to indicate that this unit is the main unit and is only valid in parallel mode.		
Parameter display at left side of screen: input parameter			
	Indicating AC input		
	Indicating PV input		
	Indicating inverter circuit		
	The icon is not displayed		
	Displaying battery voltage, total charge current of battery, charge power of mains supply, AC input voltage, AC input frequency, PV input voltage, temperature of internal radiator, software version		
Parameter display at right side of screen: output parameter			
	Indicating output voltage, output current, output active power, output apparent power, battery discharge current, software version; under setting mode, displaying the setting parameter under the parameter item code set currently		
Arrow display			
①	The arrow is not displayed	⑤	Indicating charge from charge circuit to battery end
②	Indicating power grid power supply to load	⑥	The arrow is not displayed
③	Indicating power grid power supply to charge circuit	⑦	Indicating power supply from battery end to inverter circuit
④	Indicating PV power supply to charge circuit	⑧	Indicating power supply from inverter circuit to load

Real-time data view method

In LCD main screen, press keys “UP” and “DOWN” to turn page and view different realtime data of the machine.

Page	Parameters on the left side of the screen	Parameters in the middle of the screen	Parameters on the right side of the screen
1	INPUT BATT V (Battery input voltage)	Fault code	OUTPUT LOAD V (Output load voltage)
2	BMS BATT V (BMS battery voltage, valid when BMS is enabled)		BMS BATT SOC (BMS battery remaining capacity percentage, valid when BMS is enabled)
3	PV TEMP °C (PV charger heatsink temperature)		PV OUTPUT KW (PV output power)
4	PV INPUT V (PV input voltage)		PV OUTPUT A (PV output current)
5	INPUT BATT A (Input battery current)		OUTPUT BATT A (Battery output current)
6	INPUT BATT KW (Battery input power)		OUTPUT BATT KW (Battery output power)
7	AC INPUT Hz (AC input frequency)		AC OUTPUT LOAD Hz (AC output frequency)
8	AC INPUT V (AC input voltage)		AC OUTPUT LOAD A (AC output load current)
9	INPUT V (For maintain)		OUTPUT LOAD KVA (Load apparent power)
10	INV TEMP °C (AC charge or battery discharge heatsink temperature)		INV OUTPUT LOAD KW (Load active power)
11	APP software version		Bootloader software version
12	Model Battery Voltage Rating		Model Output Power Rating
13	Model PV Voltage Rating		Model PV Current Rating
14	RS485 address		Phase sequence display

4.5 Setting parameters

Key operation description: to enter setting menu and exit from setting menu, please press key "SET" . After entering the setting menu, parameter number 【00】 shall flash. At this time, press keys " UP " and " DOWN " to select the parameter item code to be set. Afterwards, press key " ENT" to enter parameter editing state. At this moment, the parameter value can flash. The parameter values are adjusted through keys "UP" and "DOWN" . In the end, press key "ENT" to complete parameter editing and return to parameter selection state.

Note: In parallel mode, all machines will synchronise the setup parameters of the host machine (the machine with "P" on the display) before switching on, and the setup parameters of any machine will be synchronised with other machines in the system after switching on.

Parameter No.	Parameter name	Setting	Description
00	Exit	[00] ESC	Exit from setting menu.
01	Work priority mode	[01] SOL	PV priority mode, when PV is invalid or battery value is lower than the parameter [04] setting value, it shall switch to AC power.
		[01] UTI default	AC priority mode, it switches to inverter only when the AC power is invalid.
		[01] SBU	Inverter priority mode, switching to mains only when the battery is under-voltage or below the value set in parameter [04]; switching to battery discharge only when the battery is fully charged or above the value set in parameter [05].
02	Output frequency	[02] 50.0 default	Bypass self-adaption, it automatically adapts to AC frequency in case of AC power; without AC power, the output frequency can be set via the menu. For 230V machine, it is 50Hz by default.
		[02] 60.0	
03	AC input voltage range	[03] APL	230V machine wide range mains input voltage range 90~280V.
		[03] UPS default	230V machine narrow range mains input voltage range 170~280V.

04	Battery to mains	[04] 43.6V default	Parameter [01] = SBU, the battery voltage is lower than this setting value, the output is switched from inverter to mains, the setting range is 40V~52V. cannot be set more than [14] setting item.
05	Mains to battery	[05] 57.6V default	Parameter [01] = SBU, the battery voltage is higher than this setting value, the output is switched from mains to inverter, the setting range is 48V~60V. It cannot be set lower than [04] and [35] setting items.
06	Charging mode	[06] CSO	PV priority charging. Only when the PV charging fails, the mains charging is started.
		[06] CUB	Mains priority charging. Only when the mains charging fails, the PV charging is started.
		[06] SNU default	PV and Mains hybrid charging. PV charging is a priority, and when the PV energy is insufficient, the mains charging supplements. When the PV energy is sufficient, the mains charging stops. Note: Only when the Mains bypass output is loaded, the PV charging and the mains charging can work at the same time. When the inverter works, only the PV charging can be started.
		[06] OSO	Only PV charging, with the mains charging not activated.
07	Maximum charging current	[07] 60A default	S series model, setting range 0~100A.
08	Battery type	[08] USE	For user-defined, all battery parameters can be set.
		[08] SLd	Sealed lead-acid battery, constant-voltage charge voltage is 57.6V, float charge voltage is 55.2V.
		[08] FLd	Flooded lead-acid battery, charge voltage at constant voltage is 58.4V and float charge voltage is 55.2V.
		[08] GEL default	Gel lead-acid battery, charge voltage at constant voltage is 56.8V and float charge voltage is 55.2V.

		[08] L14/L15/L16	Lithium iron phosphate battery L14/L15/L16 corresponds to lithium iron phosphate battery 14, 15, 16 strings. 16 strings, constant-voltage charge voltage is 56.8V. 15 strings, constant-voltage charge voltage is 53.2V. 14 strings, constant-voltage charge voltage is 49.2V.
		[08] N13/N14	Ternary lithium battery, which is adjustable. N13, constant-voltage charge voltage is 53.2V. N14, constant-voltage charge voltage is 57.6V.
09	Boost charging voltage	[09] 56.8V default	The setting range of boost charging voltage is 48V~58.4V with 0.4V step. Valid when the battery type is user-define and lithium.
10	Boost charging maximum time	[10] 120 default	Boost maximum charge time setting means setting of maximum charge time of voltage when the voltage reaches parameter [09] from 5min~900min at 5-minute step.
11	Float voltage	[11] 55.2V default	48V~58.4V setting range of float voltage at 0.4V step.
12	Over-discharging voltage	[12] 42V default	When the battery voltage is lower than the judgement point, after delaying for the parameter [13] setting time, turn off the inverter output. 40V~52V voltage setting range at 0.4V step.
13	Over-discharging delay time	[13] 5S default	So as to overdischarge delay time, when the battery voltage is lower than parameter [12], the inverter output is turned off after delaying the time set with the parameter. 5S~50S setting range at 5S step.
14	Battery under-voltage alarm point	[14] 44V default	When the battery voltage is lower than the judgement point, an undervoltage alarm is given out and no turnoff is output. 40V~52V setting range at 0.4V step.

15	Battery discharging limit voltage	[15] 40V default	When the battery voltage is lower than the judgement point, the output is turned off immediately. 40V~52V setting range at 0.4V step. Valid when the battery type is user-define and lithium.
16	Equalized charging	[16] DIS default	Disable equalized charging.
		[16] ENA	Enable equalized charging. Valid when battery type is flooded lead-acid batteries, sealed lead-acid batteries and user-defined.
17	Equalized charging voltage	[17] 56.8V default	48V~58.4V setting range at 0.4V step. Valid when the battery type is flooded lead-acid battery, sealed lead-acid battery and user-define.
18	Equalized charging time	[18] 120 default	5min~900min setting range at 5min step. Valid when the battery type is flooded lead-acid battery and sealed lead-acid battery.
19	Equalized charging delay	[19] 240 default	5min~900min setting range at 5min step. Valid when the battery type is flooded lead-acid battery, sealed lead-acid battery and user-define.
20	Equalized charging interval	[20] 30 default	0~30days setting range at 1-day step. Valid when the battery type is flooded lead-acid battery, sealed lead-acid battery and user-define.
21	Equalized charging enable	[21] ENA	Start equalized charging immediately.
		[21] DIS default	Stop equalized charging immediately.
22	Energy-saving mode	[22] DIS default	Disable energy-saving mode.
		[22] ENA	After the power saving mode is enabled, if the load is null or less than 50W, the inverter output is turned off after a delay for a certain period of time. When the load is more than 50W, the inverter automatic restart.
23	Automatic restart after overload	[23] DIS	When the automatic restart after overload is disabled, if the output is turned off upon overload, the machine shall not restore.

		[23] ENA default	When the automatic restart after overload is enabled, if the output is turned off upon overload, output is restarted by the mains after 3min delay. The machine shall not restarted after 5 times of restarts.
24	Automatic restart after over-temperature	[24] DIS	When automatic restart after over-temperature is disabled, if over-temperature occurs to switch off the output, the machine will no longer switch on the output.
		[24] ENA default	When automatic restart after over-temperature is enabled, If an over-temperature occurs to turn off the output, it will restart to turn on the output when the temperature drops.
25	Buzzer alarm	[25] DIS	Disable alarm.
		[25] ENA default	Enable alarm.
26	Mode change alert	[26] DIS	Disable alarm, when the state of the main input source changes.
		[26] ENA default	Enable alarm, when the state of the main input source changes.
27	Inverter overload to bypass	[27] DIS	Disable automatic switching to mains when inverter is overloaded.
		[27] ENA default	Enable automatic switching to mains when inverter is overloaded.
28	Maximum AC charging current	[28] 60A default	Maximum AC charging current setting. Setting range 0~60A, default 60A.
30	Communication address setting	[30] 1 default	Parallel mode needs to be set, the setting range is 1-6, and cannot be set in parallel operation. Note: Parallel mode can assign address automatically, usually no need to set manually.
31	AC output mode (settable in standby mode only)	[31] SIG default	Single machine setting.
		[31] PAL	Single-phase parallel connection setting.

		[31] 3P1/3P2/3P3	Three-phase parallel connection setting.
		<p>All machines in phase 1 must be set as "3P1" .</p> <p>All machines in phase 2 must be set as "3P2" .</p> <p>All machines in phase 3 must be set as "3P3" .</p> <p>When the output voltage set in the setting [38] is 230Vac (S model):</p> <p>At present, the voltage phase difference between (P1-P2, P1-P3, P2-P3) is 120 degrees, the line voltage between the live wire L1 in phase 1 and the live wire L2 in phase 2 is $230 \times 1.732 = 398\text{Vac}$, and similarly the line voltage between L1-L3, L2-L3 is 398Vac; the single phase voltage between L1-N, L2-N, L3-N is 230Vac.</p>	
32	RS485-2 communication	[32] SLA default	RS485-2 port for PC and remote monitoring protocol.
		[32] BMS	RS485-2 port for BMS communication.
33	BMS communication protocols	When [32] setting item = BMS, you need to select the corresponding lithium battery manufacturer's brand for communication.	
		PAC=PACE, RDA=RITAR, AOG=ALLGRAND, OLT=OLITER, HWD=SUNWODA, DAQ=DYNESS, WOW=SRNE, PYL=PYLONTECH, UOL=VILION	
34	Hybrid power to load and on-grid setting	[34] DIS default	Disable this function.
		[34] Lod	Hybrid power to load mode, in which the PV is only charged first in utility mode and the remaining energy is supplied to the load and not fed into the grid.
		[34] Grd	On-grid function, in utility mode, the PV is charged first and the remaining energy is supplied to the load and fed into the grid.

35	Low-voltage disconnect battery voltage recovery point (fault 04)	[35] 52V default	When the battery low voltage disconnects the inverter output, the battery voltage needs to be greater than this setting to restore the battery inverter AC output.
36	Maximum PV charging current	[36] 80A default	Maximum PV charging current setting: 0~100A.
37	Battery fully charged recovery point	[37] 52V default	After the battery is fully charged, it needs to be lower than this set voltage before it can be recharged.
38	AC output voltage setting	[38] 230Vac default	S series models: allow to set to 200 / 208 / 220 / 230 / 240Vac, default 230Vac. AC output power = (Rated Power)*(Setting voltage/230)

<p>39</p>	<p>Charging current limiting method</p>	<p>[39] BMS default</p>	<p>This mode only takes effect when the inverter communicates successfully with the lithium battery BMS (Battery Management System), and the following options can be set:</p> <p>[SET] When this option is selected, the inverter charging current adopts the value set in item [07], in which case item [07] can be set to any value from 0 to the maximum charging current.</p> <p>[BMS] When this option is selected, the charging limit current transmitted by BMS and the value set in [07] will be compared, and the smaller value will be taken as the current charging current, in this case, the charging current that can be set in [07] can not be greater than the the charging limit current of BMS.</p> <p>After [INV] is selected, it will compare the inverter internal current limit value with the value set in item [07], and take the smaller of them as the current charging current. At this time, charging current can be set in item [07] can not be greater than the inverter internal current limit value, and the logic for the inverter internal current limit value is:</p> <ol style="list-style-type: none"> 1. When the battery SOC>98%, the charging current is reduced to 1/16 of the rated charging current value of the inverter. 2. When the battery SOC>95%, the charging current is reduced to 1/8 of the rated charging current of the inverter. 3. When the battery SOC>90%, the charging current is reduced to the inverter rated charging current value 1/4. 4. When battery SOC>85%, the charging current is reduced to the inverter rated charging current 1/2.
<p>57</p>	<p>Stop charging current</p>	<p>[57] 2A default</p>	<p>Stop charging when the charging current is less than the set value.</p>
<p>58</p>	<p>Discharge alarm SOC setting</p>	<p>[58] 15% default</p>	<p>SOC alarm when capacity is less than this setting. (Valid when BMS communication is normal)</p>

59	Stop discharging SOC setting	[59] 5% default	Discharge stops when the capacity is less than this setting value. (Valid when BMS communication is normal)
60	Stop charging SOC setting	[60] 100% default	When the capacity is greater than this setting value, charging stops. (Valid when BMS communication is normal)
61	Switching to mains SOC setting	[61] 10% default	When the capacity is less than this setting value, switch to mains power. (Valid when BMS communication is normal)
62	Switch to inverter output SOC setting	[62] 100% default	When the capacity is greater than this setting, switch to inverter output mode. (Valid when BMS communication is normal)

4.6 Battery type parameters

For Lead-acid Battery :

Battery type Parameters	Sealed lead acid battery (SLD)	Gel lead acid battery (GEL)	Flooded lead acid battery (FLD)	User-defined (USE)	Adjustable
Overvoltage disconnection voltage	60V	60V	60V	60V	
Battery fully charged recovery point(setup item [37])	52V	52V	52V	52V	√
Equalizing charge voltage	58.4V	-	59.2V	40 ~ 60V	√
Boost charge voltage	-	-	-	40 ~ 60V	√
Floating charge voltage	55.2V	55.2V	55.2V	40 ~ 60V	√
Undervoltage alarm voltage([01] fault)	44V	44V	44V	40 ~ 60V	√
Undervoltage alarm voltage recovery point([01] fault)	Undervoltage alarm voltage+0.8V				
Low voltage disconnection voltage([04] fault)	42V	42V	42V	40 ~ 60V	√
Low voltage disconnection voltage recovery point ([04] fault)(setup item [35])	52V	52V	52V	52V	√
Discharge limit voltage	-	-	-	40 ~ 60V	√
Over-discharge delay time	5s	5s	5s	1 ~ 30s	√
Equalizing charge duration	120 minutes	-	120 minutes	0 ~ 600 minutes	√
Equalizing charge interval	30 days	-	30 days	0 ~ 250 days	√
Boost charge duration	-	-	-	10 ~ 600 minutes	√

For Lithium Battery :

Battery type Parameters	Ternary (N13)	Ternary (N14)	LFP (L16)	LFP (L15)	LFP (L14)	Adjustable
Overvoltage disconnection voltage	60V	60V	60V	60V	60V	
Battery fully charged recovery point(setup item [37])	50.4V	54.8V	53.6V	50.4V	47.6V	√
Equalizing charge voltage	-	-	-	-	-	√
Boost charge voltage	53.2V	57.6V	56.8V	53.2V	49.2V	√
Floating charge voltage	53.2V	57.6V	56.8V	53.2V	49.2V	√
Undervoltage alarm voltage([01] fault)	43.6V	46.8V	49.6V	46.4V	43.2V	√
Undervoltage alarm voltage recovery point([01] fault)	Undervoltage alarm voltage+0.8V					
Low voltage disconnection voltage([04] fault)	38.8V	42V	48.8V	45.6V	42V	√
Low voltage disconnection voltage recovery point ([04] fault)(setup item [35])	46V	49.6V	52.8V	49.6V	46V	√
Discharge limit voltage	36.4V	39.2V	46.4V	43.6V	40.8V	√
Over-discharge delay time	30s	30s	30s	30s	30s	√
Equalizing charge duration	-	-	-	-	-	
Equalizing charge interval	-	-	-	-	-	
Boost charge duration	120 minutes	120 minutes	120 minutes	120 minutes	120 minutes	√

5. Other Function

5.1 Dry contact function

Working principle: this dry node can control the switch of diesel generator to charge the battery.

- ① Under normal conditions, in this terminal, NC-N point is closed and NO-N point is opened;
- ② when the battery voltage reaches the low-voltage disconnection voltage point, the coil of the relay is energized and NO-N point is closed and NC-N point opened. At this time, NO-N point can drive resistive loads 125VAC/1A, 230VAC/1A and 30VDC/1A.

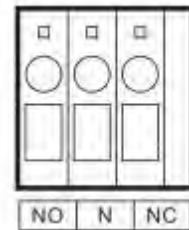

5.2 RS485 communication function

There are two communication ports, RS485 and WIFI, and two functions:

- ① RS485 port allows RS485 communication with lithium battery BMS.
- ② WIFI port can be connected with our self-developed RS485 to WIFI/GPRS communication module, which can be connected to our reverse control machine, and you can check the operation parameters and status of the reverse control machine through mobile phone APP.
- ③ As shown in the figure:

RS485: pin 1 for 5V power, pin 2 for GND, pin 7 for RS485-A1, pin 8 for RS485-B1.

WIFI: pin 1 for 5V power, pin 2 for GND, pin 7 for RS485-A2, pin 8 for RS485-B2.

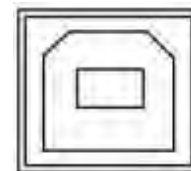
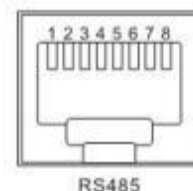

5.3 USB communication function

This port is a USB communication port, which can be used for USB communication with the selected upper computer software of our company (Need to apply for). To use this port, the corresponding “USB to serial port chip CH340T driver” should be installed in the computer.

5.4 Parallel communication function (parallel operation only)

- a) This port is used for parallel communication, through which the parallel modules can communicate with each other.
- b) Each inverter has two DB15 ports, one for the male connector and the other for the female connector.
- c) When connecting, make sure to connect the male connector of the inverter with the female connector of the inverter to be paralleled, or connect the female connector of the inverter to the male connector of the inverter to be paralleled.

- d) Do not connect the male connector of the inverter to its female connector.



5.5 Current sharing detection function (parallel operation only)

- a) This port is used for current sharing detection, through which the current sharing of the parallel modules can be detected (parallel operation only).
- b) Each inverter has two current sharing detection ports, which are connected in parallel. When it is connected to other models to be paralleled, either port can be connected for convenience. There is no special mandatory wiring requirements.

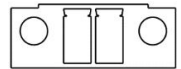

6. Protection

6.1 Protection function

No.	Protections	Description
1	PV current/power limiting protection	When charging current or power of the PV array configured exceeds the PV rated, it will charge at the rated.
2	PV night reverse-current protection	At night, the battery is prevented from discharging through the PV module because the battery voltage is greater than the voltage of PV module.
3	Mains input over voltage protection	When the mains voltage exceeds 280V, the mains charging will be stopped and switched to the inverter mode.
4	Mains input under voltage protection	When the mains voltage is lower than 170V (230V model /UPS mode), the mains charging will be stopped and switched to the inverter mode.
5	Battery over voltage protection	When the battery voltage reaches the overvoltage disconnection point, the PV and the mains will be automatically stopped to charge the battery to prevent the battery from being overcharged and damaged.
6	Battery low voltage protection	When the battery voltage reaches the low voltage disconnection point, the battery discharging will be automatically stopped to prevent the battery from being over-discharged and damaged.
7	Load output short circuit protection	When a short-circuit fault occurs at the load output terminal, the AC output is immediately turned off and turned on again after 1 second.
8	Heat sink over temperature protection	When the internal temperature is too high, the all-in-one machine will stop charging and discharging; when the temperature returns to normal, charging and discharging will resume.
9	Overload protection	Output again 3 minutes after an overload protection, and turn the output off after 5 consecutive times of overload protection until the machine is re-powered. For the specific overload level and duration, refer to the technical parameters table in the manual.
10	PV reverse polarity protection	When the PV polarity is reversed, the machine will not be damaged.
11	AC reverse protection	Prevent battery inverter AC current from being reversely input to Bypass.

12	Bypass over current protection	Built-in AC input overcurrent protection circuit breaker.
13	Battery input over current protection	When the discharge output current of the battery is greater than the maximum value and lasts for 1 minute, the AC input would switched to load.
14	Battery input protection	When the battery is reversely connected or the inverter is short-circuited, the battery input fuse in the inverter will blow out to prevent the battery from being damaged or causing a fire.
15	Charge short-circuit protection	When the external battery port is short-circuited in the PV or AC charging state, the inverter will protect and stop the output current.
16	CAN communication loss protection	In parallel operation, an alarm will be given when CAN communication is lost.
17	Parallel connection error protection	In parallel operation, the equipment will be protected when the parallel line is lost.
18	Parallel battery voltage difference protection	In parallel operation, the equipment will be protected when the battery connection is inconsistent and the battery voltage is greatly different from that detected by the host.
19	Parallel AC voltage difference protection	In parallel operation, the equipment will be protected when the AC IN input connection is inconsistent.
20	Parallel current sharing fault protection	In parallel operation, the running equipment will be protected when the load difference of each inverter is large due to improper connection of current sharing line or device damage.
21	Synchronization signal fault protection	The equipment will be protected when there is a fault in the guidance signal between parallel buses, causing inconsistent behavior of each inverter.

6.2 Meaning of fault code

Fault code	Fault name	Whether it affects the output or not	Description
【01】	BatVoltLow	No	Battery undervoltage alarm
【02】	BatOverCurrSw	Yes	Battery discharge average current overcurrent software protection
【03】	BatOpen	Yes	Battery not-connected alarm
【04】	BatLowEod	Yes	Battery undervoltage stop discharge alarm
【05】	BatOverCurrHw	Yes	Battery overcurrent hardware protection
【06】	BatOverVolt	Yes	Charging overvoltage protection
【07】	BusOverVoltHw	Yes	Bus overvoltage hardware protection
【08】	BusOverVoltSw	Yes	Bus overvoltage software protection
【09】	PvVoltHigh	No	PV overvoltage protection
【10】	PvBoostOCSw	No	Boost overcurrent software protection
【11】	PvBoostOCHw	No	Boost overcurrent hardware protection
【12】	bLineLoss	No	Mains power down
【13】	OverloadBypass	Yes	Bypass overload protection
【14】	OverloadInverter	Yes	Inverter overload protection
【15】	AcOverCurrHw	Yes	Inverter overcurrent hardware protection
【17】	InvShort	Yes	Inverter short circuit protection

【19】	OverTemperMpp t	No	Buck heat sink over temperature protection
【20】	OverTemperInv	Yes	Inverter heat sink over temperature protection
【21】	FanFail	Yes	Fan failure
【22】	EEPROM	Yes	Memory failure
【23】	ModelNumErr	Yes	Model setting error
【26】	RlyShort	Yes	Inverted AC Output Backfills to Bypass AC Input
【29】	BusVoltLow	Yes	Internal battery boost circuit failure
【30】	BatCapacityLow1	No	Battery capacity below 10% alarm (valid when BMS is enabled)
【31】	BatCapacityLow2	No	Battery capacity below 5% alarm (valid when BMS is enabled)
【32】	BatCapacityLowS top	Yes	Battery low capacity shutdown (valid when BMS is enabled)
【34】	CanCommFault	Yes	CAN communication fault in parallel operation
【35】	ParaAddrErr	Yes	Parallel ID setting error
【36】	-	-	-
【37】	ParaShareCurrErr	Yes	Parallel current sharing fault
【38】	ParaBattVoltDiff	Yes	Large battery voltage difference in parallel mode
【39】	ParaAcSrcDiff	Yes	Inconsistent AC input source in parallel mode
【40】	ParaHwSynErr	Yes	Hardware synchronization signal error in parallel mode
【41】	InvDcVoltErr	Yes	Inverter DC voltage error

【42】	SysFwVersionDiff	Yes	Inconsistent system firmware version in parallel mode
【43】	ParaLineContErr	Yes	Parallel line connection error in parallel mode
【44】	Serial number error	YES	If the serial number is not set by omission in production, please contact the manufacturer to set it
【45】	Error setting of splitphase mode	YES	【31】 settings item setting error
【58】	BMS communication fault	NO	Check whether the communication cable is connected correctly and whether item [33] is set to the corresponding lithium battery communication protocol
【59】	BMS alarm	NO	Check the BMS fault type and troubleshoot battery problems
【60】	BMS battery low-temperature alarm	NO	Li-ion battery BMS low-temperature alarm
【61】	BMS battery over-temperature alarm	NO	Li-ion battery BMS over-temperature alarm
【62】	BMS battery over-current alarm	NO	Li-ion battery BMS over-current alarm
【63】	BMS battery under-voltage alarm	NO	Li-ion battery BMS under-voltage alarm
【64】	BMS battery over-voltage alarm	NO	Li-ion battery BMS over-voltage alarm

6.3 Some fault troubleshooting

Fault code	Faults	Remedy
Display	No display on the screen	Check if the battery the PV air switch has been closed; if the switch is in the "ON" state; press any button on the screen to exit the screen sleep mode.
【06】	Battery overvoltage protection	Measure if the battery voltage exceeds rated, and turn off the PV array air switch and Mains air switch.
【01】 【04】	Battery undervoltage protection	Charge the battery until it returns to the low voltage disconnection recovery voltage.
【21】	Fan failure	Check if the fan is not turning or blocked by foreign object.
【19】 【20】	Heat sink over temperature protection	When the temperature of the device is cooled below the recovery temperature, normal charge and discharge control is resumed.
【13】 【14】	Bypass overload protection, inverter overload protection	① Reduce the use of power equipment; ② Restart the unit to resume load output.
【17】	Inverter short circuit protection	① Check the load connection carefully and clear the short-circuit fault points; ② Re-power up to resume load output.
【09】	PV overvoltage	Use a multimeter to check if the PV input voltage exceeds the maximum allowable input voltage rated.
【03】	Battery disconnected alarm	Check if the battery is not connected or if the battery circuit breaker is not closed.
【40】 【43】	Parallel connection fault	Check whether the parallel line is not connected well, such as loose or wrong connection.
【35】	Parallel ID setting error	Check whether the setting of parallel ID number is repeated.
【37】	Parallel current sharing fault	Check whether the parallel current sharing line is not connected well, such as loose or wrong connection.
【39】	Inconsistent AC input source in parallel mode	Check whether the parallel AC inputs are from the same input interface.
【42】	Inconsistent system firmware version in parallel mode	Check whether the software version of each inverter is consistent.

7. System Maintenance

➤ **In order to maintain the best long-term performance, it is recommended to conduct following checks twice a year.**

1. Confirm that the air flow around the machine will not be blocked. In addition, remove any dirt or debris from the radiator.
2. Check whether the insulation of all exposed wires is damaged due to sun exposure, friction with other objects around, dry rot, insect or rat damage, etc. If necessary, it is required to repair or replace the wires.
3. Verify that the indication and display are consistent with the operation of the device. Please pay attention to any fault or error display and take corrective measures if necessary.
4. Check all terminals for corrosion, insulation damage, high temperature or burning/discoloration sign, and tighten the terminal screws.
5. Check for dirt, nesting insects and corrosion phenomenon and clean as required.
6. If the arrester has failed, replace the failed arrester in time to protect the machine and other user device against lightning damage.

Warning: Danger of electric shock! To perform above operations, make sure that all the power supplies of the machine have been broken and all the capacitor electricity has been discharged. Afterwards, corresponding inspection or operation can be performed!

➤ **We are not responsible for any following damage:**

- ① Damage caused by improper use or use in inappropriate place.
- ② Open-circuit voltage of PV module exceeds maximum allowable voltage.
- ③ The damage caused by the operation ambient temperature beyond the limited operation temperature range.
- ④ Personally take apart and maintain the machine.
- ⑤ Damage caused by force majeure: damage caused by transportation and handling of the machine.

8. Technical Parameter

Models	KE-5K5L1EF
Parallel mode	
Permitted parallel number	1~6 units
AC mode	
Rated input voltage	220/230Vac
Input voltage range	(170Vac~280Vac) $\pm 2\%$ (90Vac-280Vac) $\pm 2\%$
Frequency	50Hz/ 60Hz (Auto detection)
Frequency Range	47 \pm 0.3Hz ~ 55 \pm 0.3Hz (50Hz); 57 \pm 0.3Hz ~ 65 \pm 0.3Hz (60Hz);
Overload/short circuit protection	Circuit breaker
Efficiency	>95%
Conversion time (bypass and inverter)	10ms (typical)
AC reverse protection	Available
Maximum bypass overload current	40A
Inverter mode	
Output voltage waveform	Pure sine wave
Rated output power (VA)	5500
Rated output power (W)	5500
Power factor	1
Rated output voltage (Vac)	230Vac
Output voltage error	$\pm 5\%$
Output frequency range (Hz)	50Hz \pm 0.3Hz 60Hz \pm 0.3Hz
Maximum Efficiency	>92%
Overload protection	(102%<load<125%): Alarm and shutdown after 5 minutes. (125%<load<150%): Alarm and shutdown after 10 seconds. Load>150%: Alarm and shutdown after 5 seconds.
Peak power	11000VA
Loaded motor capability	4HP
Output short-circuit protection	circuit-breaker
Bypass circuit breaker specifications	40A
Rated battery input voltage	48V (Minimum starting voltage 44V)
Battery voltage range	40.0Vdc~60Vdc \pm 0.6Vdc (undervoltage alarm/turnoff voltage/overvoltage alarm/overvoltage restoration...settable LCD screen)
Power saving mode self-consumption	Load \leq 50W
Mains output (AC)	
Rated power	5500W

Max. apparent power	5500VA
Max. output current	24
THDI	< 3%
Rated voltage	230Vac
Rated frequency	50Hz/60Hz
AC charging	
Battery type	Lead acid or lithium battery
Maximum charge current(can be set)	60A
Charge current error	± 3A _{dc}
Charge voltage range	40 ~58V _{dc}
Short circuit protection	Circuit breaker and blown fuse
Circuit breaker specifications	40A
Overcharge protection	Alarm and stop charging after 1 minute
PV charging	
Maximum PV open circuit voltage	500V _{dc}
PV operating voltage range	120-500V _{dc}
MPPT voltage range	120-450V _{dc}
Battery voltage range	40-60V _{dc}
Maximum PV input power	6000W
Maximum PV input current	22A
PV charging current range (can be set)	0-100A
Charging short circuit protection	Blown fuse
Wiring protection	Reverse polarity protection
Hybrid charging maximum charging current specifications (AC charging+PV charging)	
Max charger current(can be set)	0-100A
Certified specifications	
Certification	CE(IEC62109-1) / CETL(UL 1741 C22.2 NO.107.1) /FCC/SAA
EMC certification level	EN61000
Operating temperature range	-10°C to 55°C
Storage temperature range	-25°C ~ 60°C
Humidity range	5% to 95% (Conformal coating protection)
Noise	≤60dB
Heat dissipation	Forced air cooling, variable speed of fan
Communication interface	USB/RS485(WiFi/GPRS)/Dry contact
Dimension	426*322*124mm
Weight	10.5kg